

IMPACT MB Pro 1 | IMPACT MB Pro 1 UC ML
IMPACT MB Pro 2 | IMPACT MB Pro 2 UC ML

Bluetooth® headset

Contents

Introduction	2
Package contents.....	3
Product overview.....	4
Overview of the headset.....	4
Overview of the headset chargers.....	4
Overview of the headset LED indications	5
Overview of the headset controls.....	6
Overview of the BTD 800 USB dongle.....	7
Overview of the dongle LED indications	7
Overview of the dongle button	7
Overview of pictograms.....	7
Putting the headset into operation	8
Charging the headset battery.....	8
Pairing the headset with Bluetooth devices.....	9
Installing the EPOS Connect software.....	11
Changing Audio settings for the headset – Microsoft® Windows	11
Using the headset	12
Switching the headset on and connecting it	12
Switching the headset off.....	12
Changing the volume	13
Individually adjusting the headset and wearing it	14
Muting the headset’s microphone.....	14
Making calls using the headset	15
Managing multiple calls.....	17
Using headset and dongle with Microsoft® Teams.....	18
Activating / deactivating the voice prompts.....	18
Activating / deactivating the room experience (MB Pro 2 only)	19
If you are out of the Bluetooth transmission range.....	19
Cleaning and maintaining the headset.....	20
Cleaning the headset and the headset charger.....	20
Replacing the ear pads.....	20
Replacing the headset’s rechargeable battery.....	21
Storing the headset.....	22
Updating the software of the product	23
If a problem occurs	24
Restoring factory default settings (Reset)	24
Specifications.....	25

Introduction

IMPACT MB Pro 1 | IMPACT MB Pro 2

The comfortable new MB Pro 1 and Pro 2 Bluetooth headsets are the wireless solution for phone calls with mobile phones and softphones with superb sound quality. The ultra noise cancelling microphone integrated into the headset filters away background noise, thus providing ultimate speech intelligibility.

Bluetooth

The headset complies with the Bluetooth 4.0 standard and is compatible with all Bluetooth 1.1, 1.2, 2.0, 2.1, 3.0 and 4.0 devices with a “hands free profile” (HFP), a “headset profile” (HSP) or an “advanced audio distribution profile” (A2DP). The headset provides wireless freedom to give hands-free convenience with your mobile phone.

Key benefits & features

- Room experience – for a more realistic sound and increased call comfort (MB Pro 2 only)
- EPOS voice clarity – for a natural speech and listening experience
- Ultra noise-canceling microphone – for perfect speech transmission
- Large leatherette ear pads – for exceptional wearing comfort and powerful sound
- Echo-free conversations – digital echo cancellation eliminates all echoes while you are talking
- HD quality sound – crystal-clear, detailed and transparent sound reproduction due to large wideband speaker and extended frequency response
- Sound-enhancement profile – for multimedia and media listening purpose
- Multi connectivity – to seamlessly manage calls between mobile devices from a single headset for maximum call-handling flexibility
- Long talk time – talk to business partners and friends for up to 15 hours, with up to 19 days of standby time
- Voice prompts for status – the user is always updated



For safety instructions, consult the Safety Guide.



The free EPOS software **EPOS Connect** allows you to add value to your EPOS products.



A list of accessories can be found on the product page at www.eposaudio.com.

Package contents

The products of the MB Pro 1 and MB Pro 2 series are available for different areas of application.

Package contents MB Pro 1/MB Pro 2

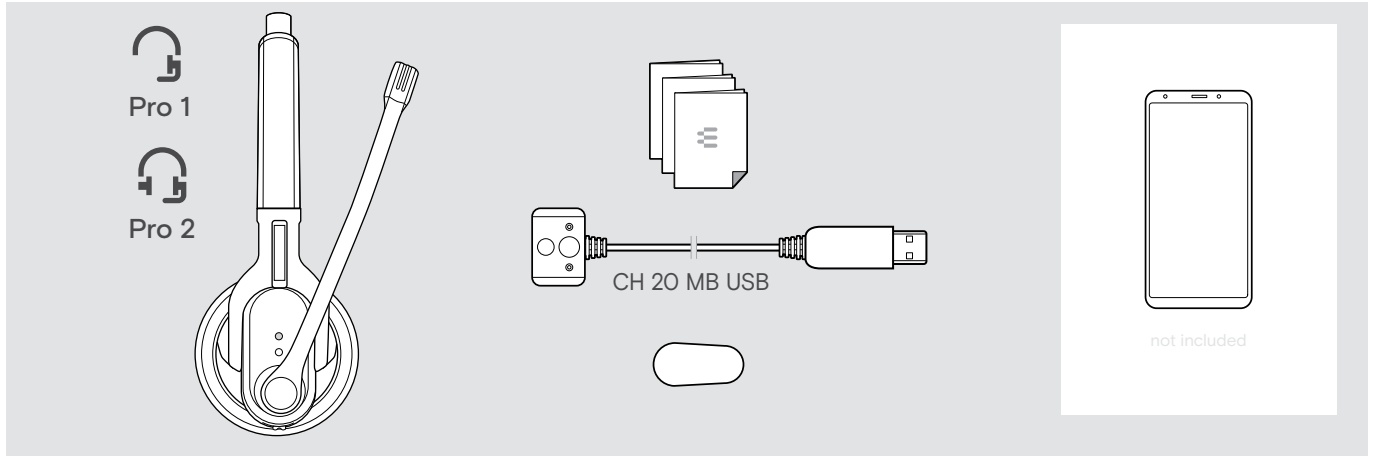

Package contents MB Pro 1 UC ML/MB Pro 2 UC ML

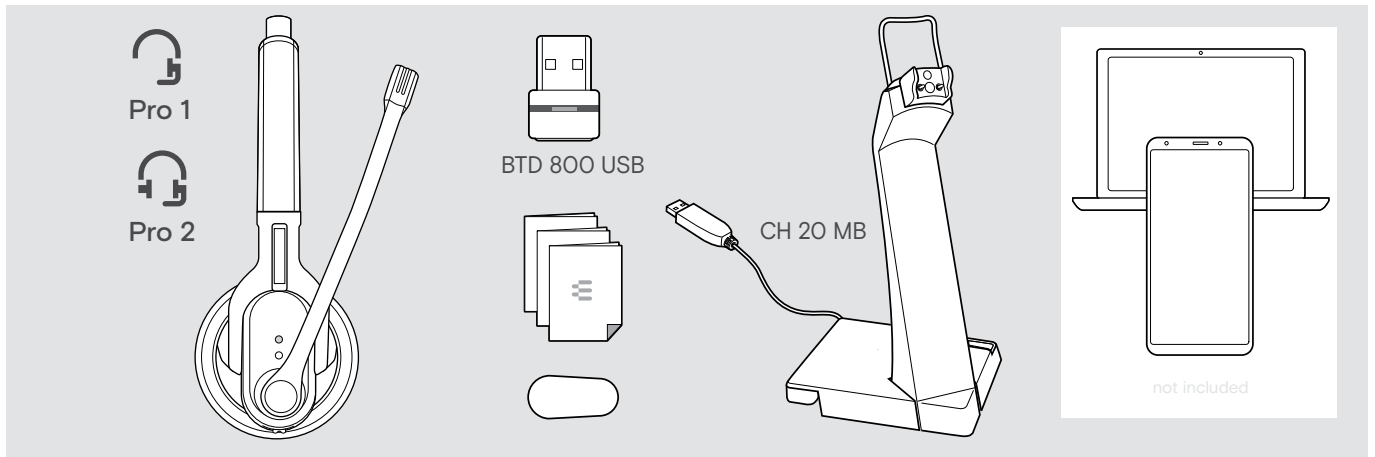

Product overview



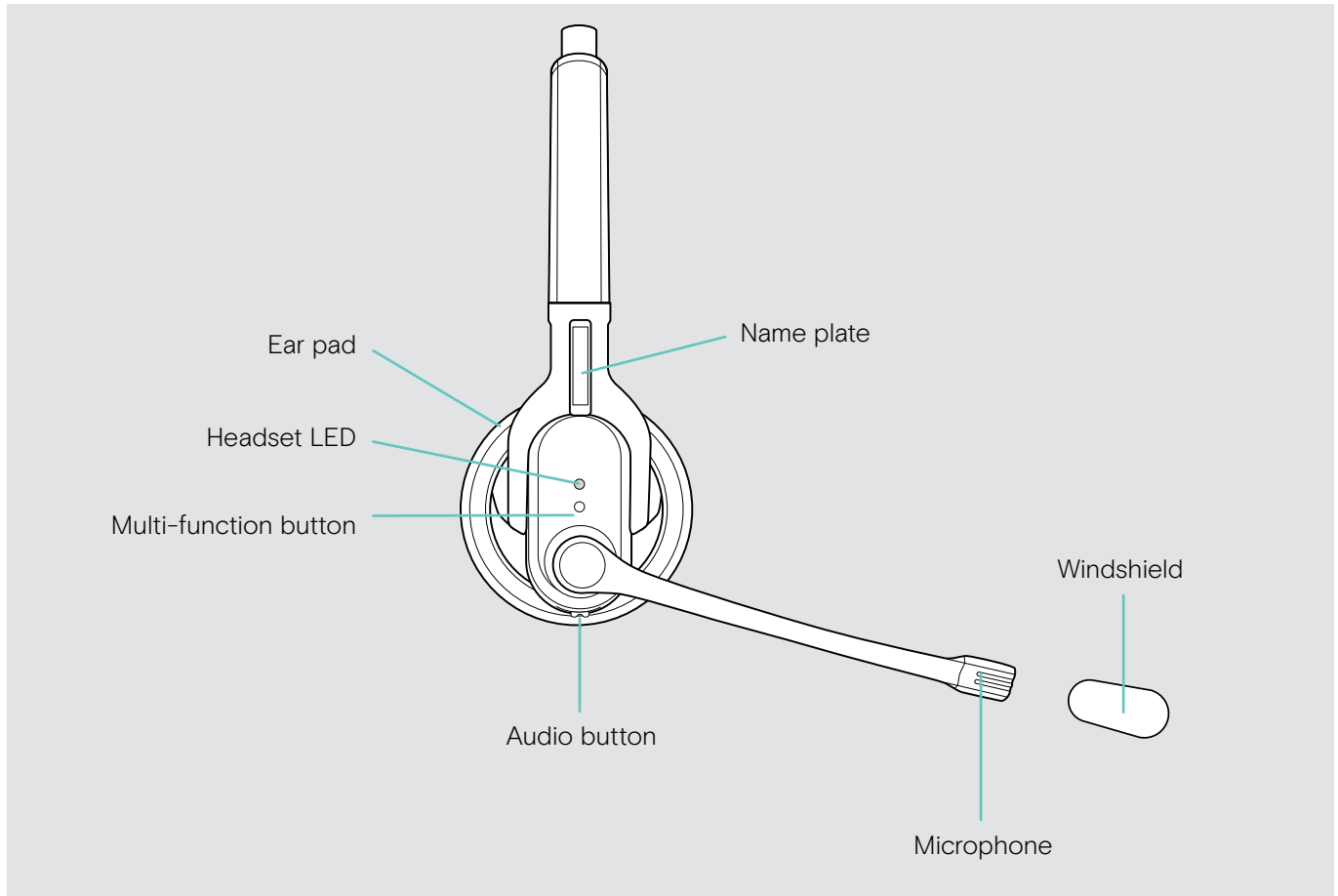



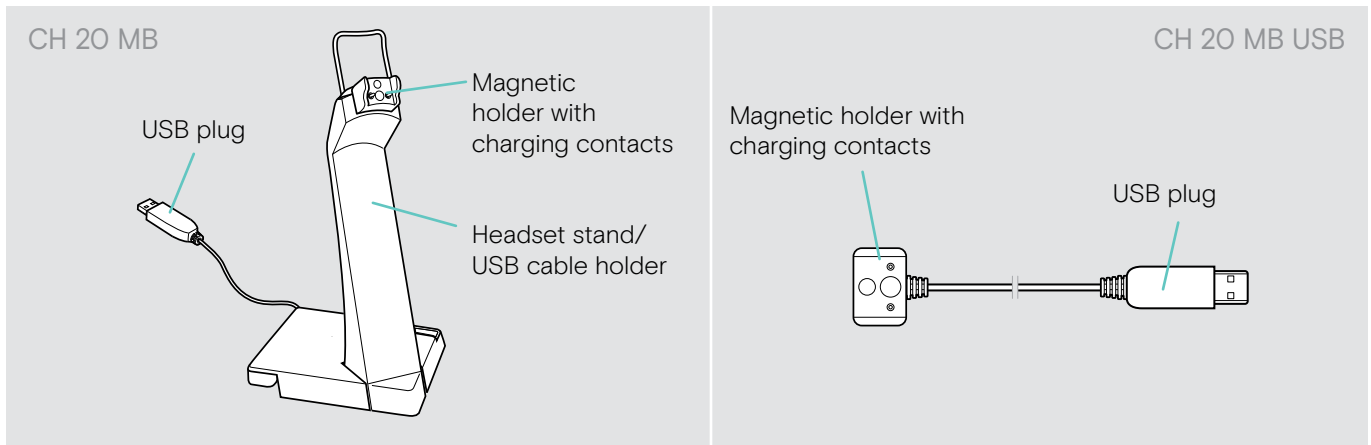



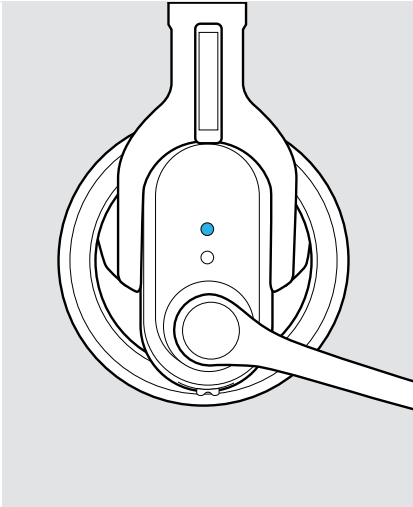









Overview of the headset



Overview of the headset chargers









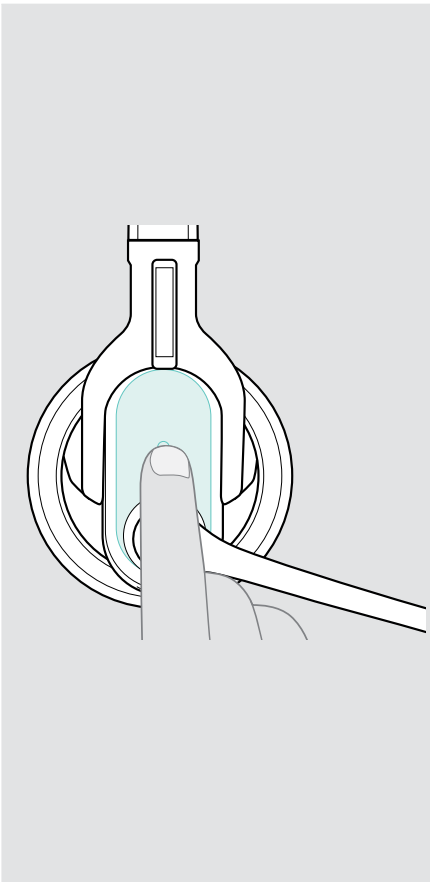

Overview of the headset LED indications



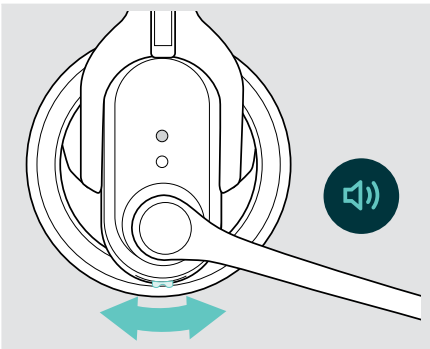

Meaning during operation	LED	Meaning
	3x 	Headset switches on
	3x 	Headset switches off
	    ...	Headset/USB dongle is in pairing mode
	3x 	Pairing was successful
	3x 	Pairing has failed or has been cancelled
	    ...	Connectable state, not connected
	    ...	Incoming call
	    ...	Incoming call + rechargeable battery is weak

Once the headset is successfully connected, the LED goes off.

Overview of the headset controls

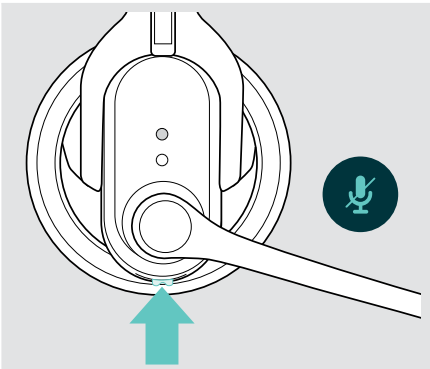
Multi-function button	Press	Function	Page
		Accepts/ends a call	15
		Accepts an incoming call and ends the active call (managing two calls)	17
		Cancels redialing	16
		Ends the active call and makes the call on hold active (managing two calls)	17
		Invokes Microsoft® Teams	18
		Transfers a call from the mobile phone to the headset	16
		Activates/cancels voice assistant	16
		Rejects a call	15
		Rejects the incoming call and continues the active call (managing two calls)	17
		Switches the headset on/off	12
		Accepts an incoming call and puts the active call on hold (managing two calls)	17
		Redials the last number	16
		Toggles between two calls (managing two calls)	17
		Activates pairing mode	9

Audio button	Move	Function	Page
		During an active call: Increases/reduces the speaker volume	13
		During media reproduction: Increases/reduces the audio volume	
		In idle mode (no active call or media reproduction): Increases/reduces the volume for the ring tone, the beeps and the voice prompts	

Audio button	Press	Function	Page
		During an active call: Mutes/unmutes the headset's microphone	14
		Changes the direction of the Audio button's volume up/down function; MB Pro 2 also changes the left and the right stereo channel	13
		Activates/deactivates the room experience for enhanced call comfort during calls (MB Pro 2 only)	19

Overview of the BTD 800 USB dongle

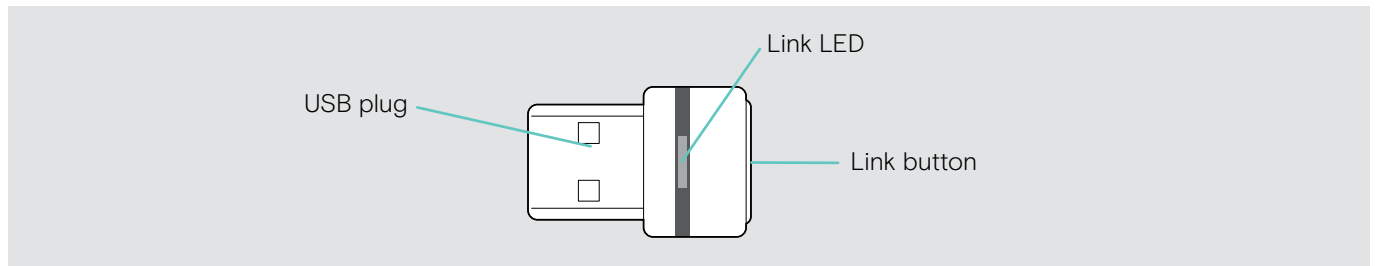

Overview of the dongle LED indications

		Dongle in pairing mode: searching for headset
	3x	Pairing successful
	3x	Pairing failed
		Dongle tries to connect to a Bluetooth device
		Dongle and Bluetooth device connected
		Incoming call
		<ul style="list-style-type: none"> Outgoing/active call Audio playback
		Connected to Teams
		<ul style="list-style-type: none"> Teams notification Connecting to Teams
		Microphone of the connected Bluetooth device is muted

Overview of the dongle button

Link button	Press	Function	Page
		Pairs the dongle with the headset	10
		Reconnects the headset	-
		Disconnects the headset	-

Overview of pictograms

	Tap the button		Notes: Good to know
	Press the button twice		LED indications
	Press and hold the button		Voice prompt is announced

Putting the headset into operation

Charging the headset battery

Before using the headset for the first time, charge the rechargeable battery for a complete charging cycle without interruption.

A complete charging cycle takes about 2 hours and 30 minutes.

🕒 2:30 h 🔋▶️ 🗣️ 15 h

🕒 40 min 🔋▶️ 🗣️ 7.5 h

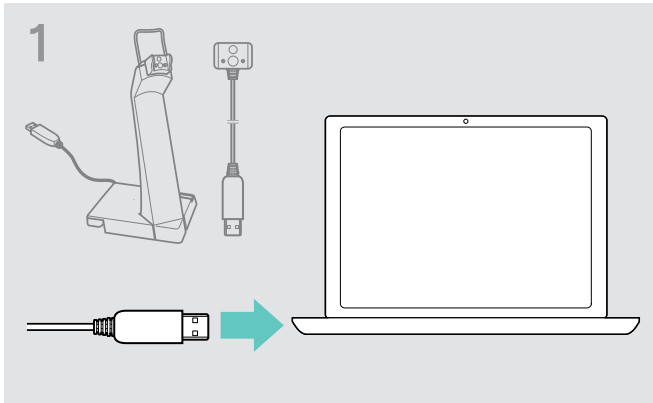

▶ Connect the USB plug of the charging cable to the USB socket of your computer.

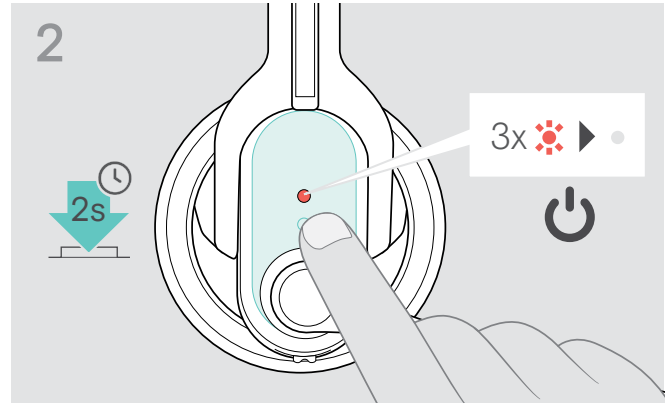

▶ Take off the headset and switch it off (see page 12).

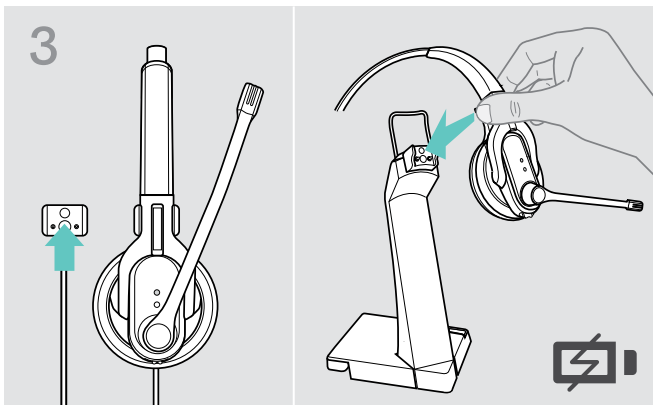

▶ Place the headset into the magnetic holder of the headset charger. The battery is being charged.

The LED flashes depending on the battery charge level. After 30 seconds, the LED goes off.

LED flashes	Remaining talk time
4x 🌟	more than 10 hours
3x 🌟	4 to 10 hours
2x 🌟	2 to 4 hours
1x 🌟	1 to 2 hours
1x 🔴	less than 1 hour

i When the battery charge level drops below 15 minutes of talk time, the LED flashes red and the voice prompt “Recharge headset” is announced several times. When the battery is flat, the headset switches off automatically.

🔋 🌟 30s 🌟 30s ... Battery is fully charged

Battery level indicator

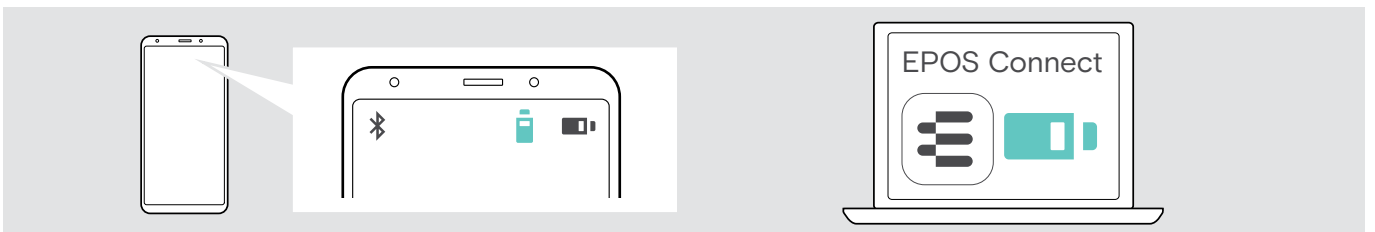

Pairing the headset with Bluetooth devices



CAUTION
Danger of malfunction!

The transmitted radio waves of mobile phones can impair the operation of sensitive and unprotected devices.

- ▶ Only make calls with the headset in locations where wireless Bluetooth transmission is permitted.

The headset complies with the Bluetooth 4.0 standard. In order that data can be transmitted wirelessly using Bluetooth technology, you have to pair your headset with Bluetooth devices that support the “hands free profile” (HFP), the “headset profile” (HSP) or the “advanced audio distribution profile” (A2DP).

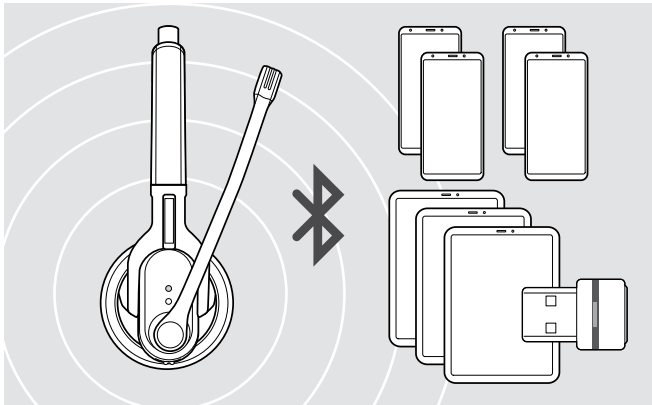

The headset can save the connection profiles of up to eight Bluetooth devices with which it has been paired.

If you pair the headset with a ninth Bluetooth device, the saved connection profile of the least used Bluetooth device will be overwritten. If you want to re-establish a connection with this Bluetooth device, you have to pair the headset again.

Using the headset with a PC and a Bluetooth USB dongle

To use the headset with a softphone, you either require a PC supporting Bluetooth or an additional Bluetooth USB dongle (wireless audio transmitter and receiver).

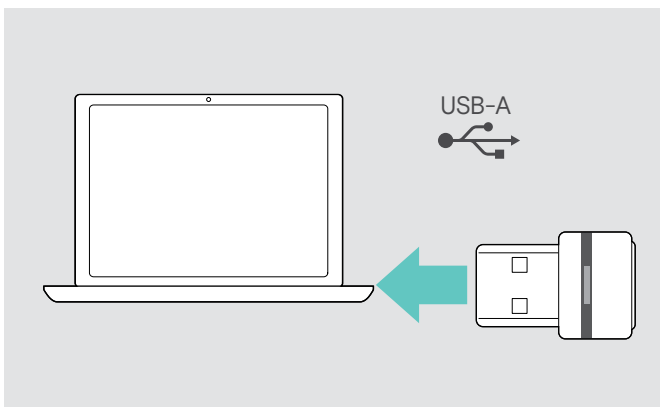

The dongle LED flashes blue while searching and switches to dimmed blue when connected successfully to the headset.



If Microsoft Teams is invoked: The dongle connects to Teams and lights up purple instead of blue.



The dongle shows Teams notifications (see page 18).

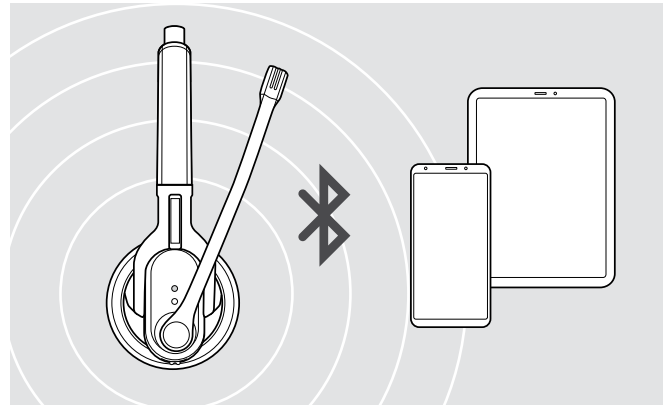

After switch-on, the headset automatically tries to connect to the two last connected Bluetooth devices.

You can only connect a third Bluetooth device after having switched off the first or the second Bluetooth device.

The BTD 800 USB Bluetooth USB dongle is supplied together with the MB Pro 1 UC/MB Pro 2 UC variants and is pre-paired with the headset.

To use the headset with a Bluetooth USB dongle:

- ▶ Plug the Bluetooth USB dongle into the USB port of your PC.
- ▶ Follow the instructions in the next chapter, as well as those given in the instruction manual of your Bluetooth USB dongle.

Pairing the headset with a Bluetooth device

The following chapter describes, by way of example of a mobile phone, how to pair the headset with a Bluetooth device. In case of deviation, proceed as described in the instruction manual of your mobile phone.

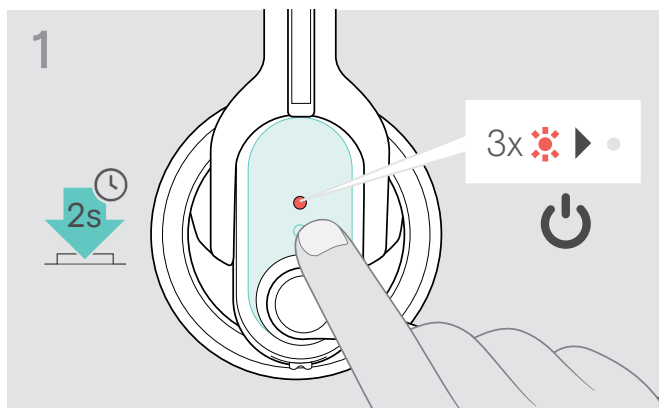

▷ Switch the headset off (see page 12).

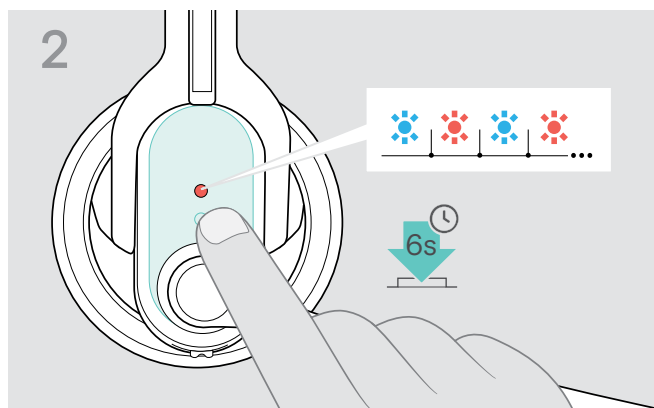

▷ Keep the multi-function button pressed until the LED alternately flashes blue and red. The headset is in pairing mode.

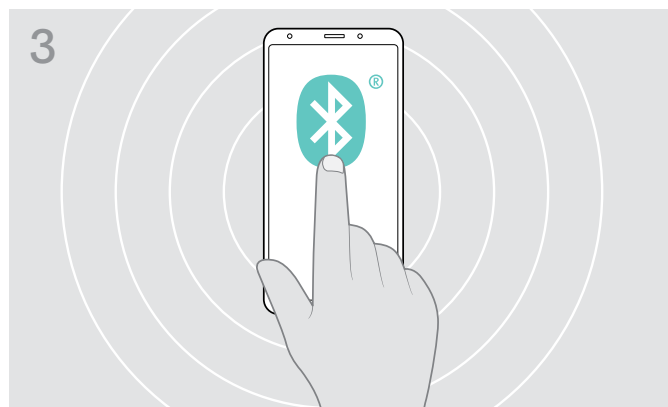

▷ Enable the Bluetooth visibility on your mobile phone.

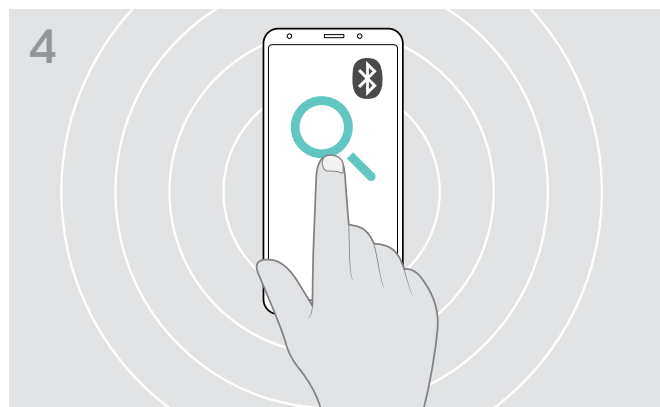

▷ Via the mobile phone's menu, start the search for new Bluetooth devices (see the instruction manual of your mobile phone). All available devices in the proximity of the mobile phone are displayed.



▷ From the found Bluetooth devices, select "MB Pro 1" or "MB Pro 2" to pair the headset with the mobile phone. If necessary, enter the default PIN code "0000".

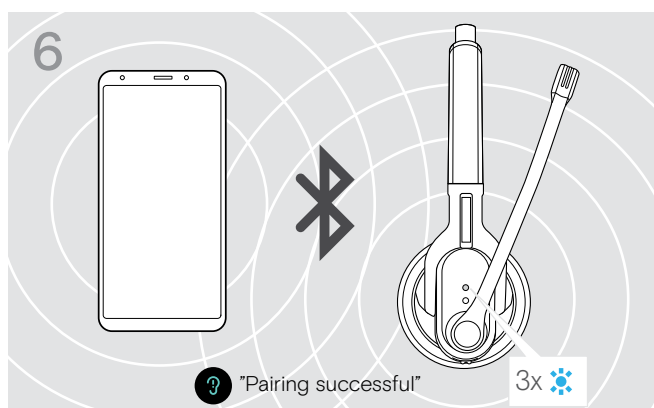

Once the headset is paired with the mobile phone, the LED goes off.



If pairing is not successful within 5 minutes, the headset automatically returns to connectable mode. Repeat the pairing procedure.

Installing the EPOS Connect software



The free **EPOS Connect** software allows you to configure and update your headset and offers additional settings.

- ▶ Download the software from www.eposaudio.com/connect.
- ▶ Install the software.
You need administrator rights on your computer – if necessary, contact your IT department.

To make calls via the computer:

- ▶ Install a softphone (VoIP Software) or ask your admin for support.

Changing Audio settings for the headset – Microsoft® Windows

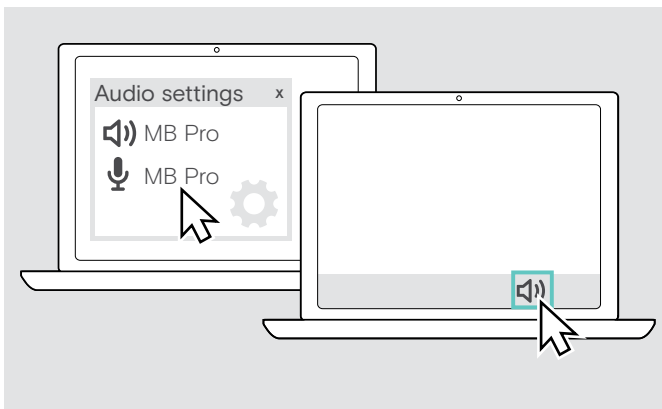

Windows usually changes the Audio settings automatically if you connect a new headset.

If the headset is connected but you hear no sound:

- ▶ Right-click the Audio icon.
- ▶ Select under output MB Pro as speaker.
- ▶ Select under input MB Pro as microphone.

Using the headset

Switching the headset on and connecting it

After switch-on, the headset automatically tries to connect to the two last connected Bluetooth devices.

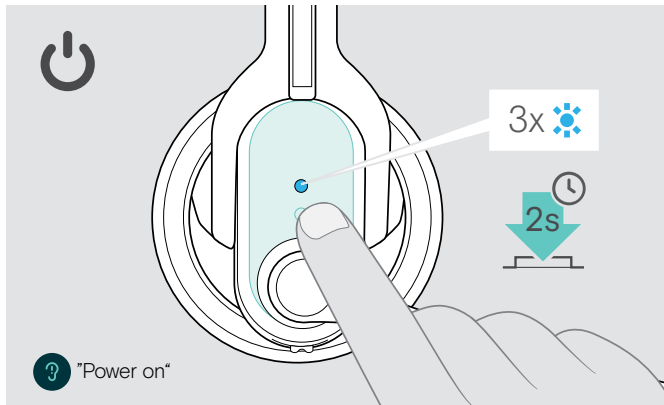

- ▶ Press the multi-function button for 2 seconds or take the headset from the magnetic holder or the charging cable. The voice prompt "Power on" is announced in the headset. The LED flashes 3 times blue every 2 seconds until the headset finds a paired Bluetooth device to connect to.

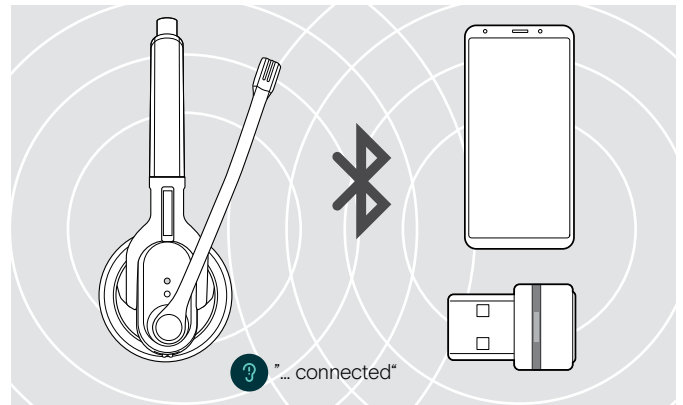

Once the connection is successfully established, one or two of the following voice prompts are announced in the headset:

- "Phone one connected" for the first mobile phone
- "Phone two connected" for the second mobile phone
- "Dongle connected" for the Bluetooth dongle.



Only two out of the maximum eight paired Bluetooth devices can be simultaneously connected to the headset.

Switching the headset off

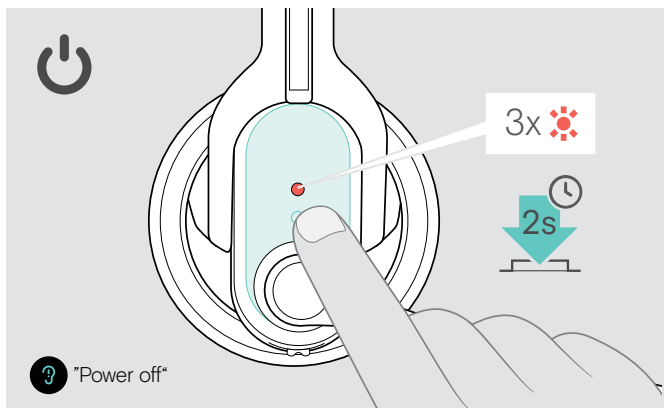

- ▶ Press the multi-function button for 2 seconds. The voice prompt "Power off" is announced in the headset and the LED flashes red 3 times. The headset ends the call and switches off.

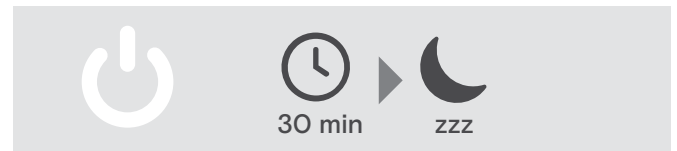

Changing the volume



CAUTION

Hearing damage due to high volumes!

Listening at high volume levels for long periods can lead to permanent hearing defects.

- ▶ Set the volume to a low level before putting on the headset.
- ▶ Do not continuously expose yourself to high volumes.



You can adjust three independent volume settings for the headset:

1. speaker volume: can be adjusted during an active call,
2. audio volume: can be adjusted during media reproduction,
3. volume for the ring tone, the beeps and the voice prompts: can be adjusted in idle mode (no active call or media reproduction)

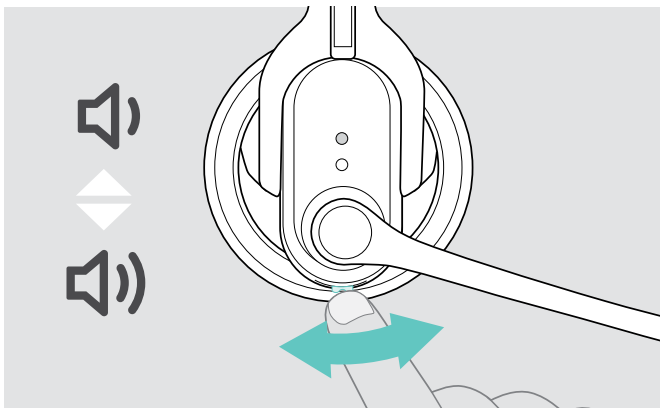

- ▶ Move the Audio button as shown, to adjust the volume. When the minimum or maximum volume is reached, the voice prompt “Volume min” or “Volume max” is announced in the headset. When the voice prompts are disabled, you hear a beep in the headset instead.

Changing the direction of the Audio button's volume up/down function

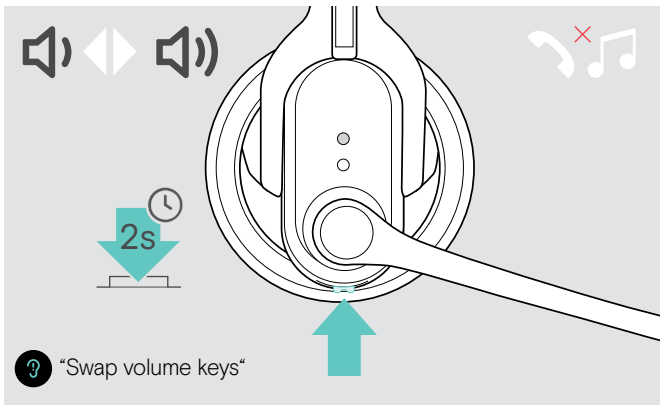

You can change the direction of the Audio button's volume up/down function if, for example, you want to wear the headset on the other ear (see page 14).

- ▶ Press and hold the multi-function button (no active call or media reproduction): The direction of the Audio button's volume up/down function is changed. The voice prompt “Swap volume keys” is announced in the headset. MB Pro 2: When the direction of the Audio button's volume up/down function is changed, the headset's left and right stereo channel is also changed to provide optimum stereo sound.

Adjusting the headset's microphone volume for softphones

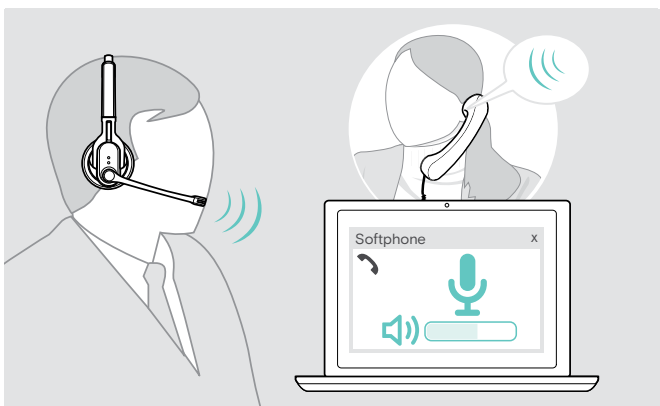

- ▶ Initiate a call on your connected device to someone who will help you find the correct volume setting for your microphone.
- ▶ Change the microphone volume in your softphone application and/or in your PC audio application.

Individually adjusting the headset and wearing it

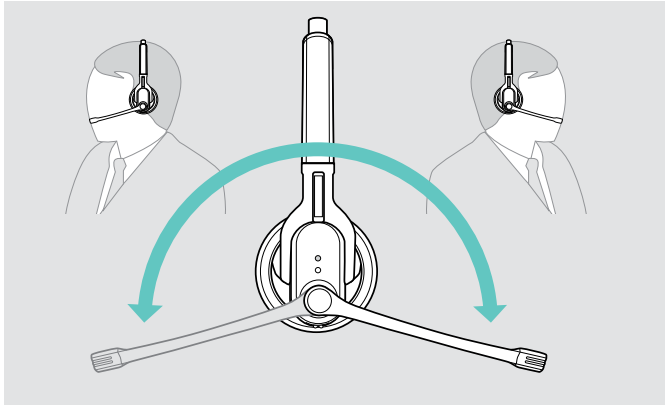

▷ Rotate the microphone boom.

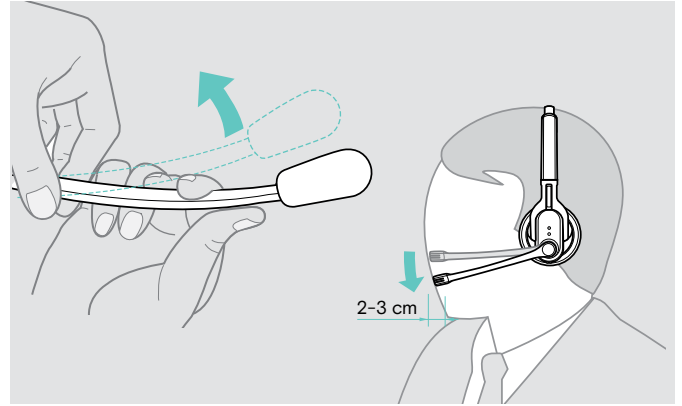

▷ Bend the microphone boom so that the microphone is about 0.8" (2 cm) from the corner of your mouth.

▷ Adjust the headset so that the

- **MB Pro 1:**
ear pad rests comfortably on your right or left ear.
- **MB Pro 2:**
the ear pads rest comfortably on your ears.

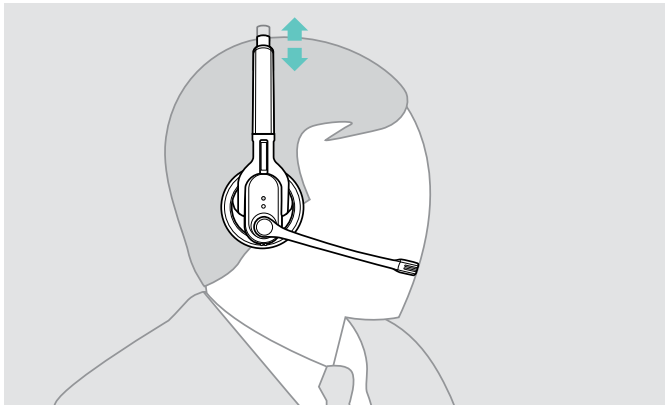

Muting the headset's microphone

▷ Press the Audio button.

The headset's microphone is muted. During the muting, the Link LED flashes red.

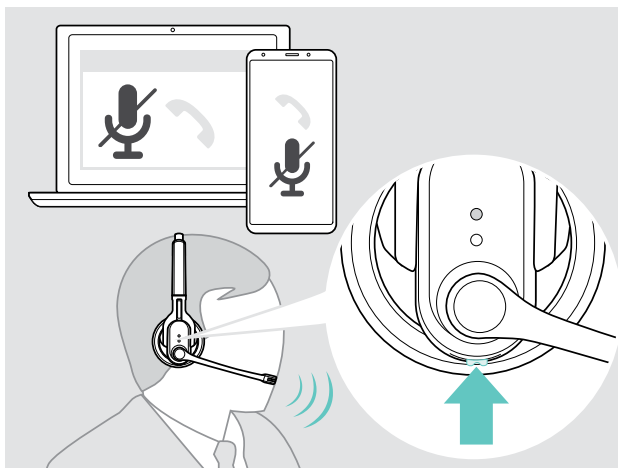

Mutes the headset's microphone "Mute on"



Unmutes the headset's microphone "Mute off"

Making calls using the headset

Making a call



- ▷ Dial the desired number on your mobile phone or softphone.
You hear a beep in the headset.

If your mobile phone does not automatically transfer the call to the headset:

- ▷ Press the multi-function button on the headset or press a corresponding button on your mobile phone (see the instruction manual of your mobile phone).

Accepting / rejecting / ending a call

When you receive a call, the headset announces which of the connected Bluetooth device is ringing:

- connected mobile phones: "Phone one" or "Phone two" or
- Bluetooth dongles connected to the PC: "Dongle"

You then hear a ring tone in the headset and the LED flashes blue. If the headset battery is low, the LED flashes red.

- ▷ Press the multi-function button:

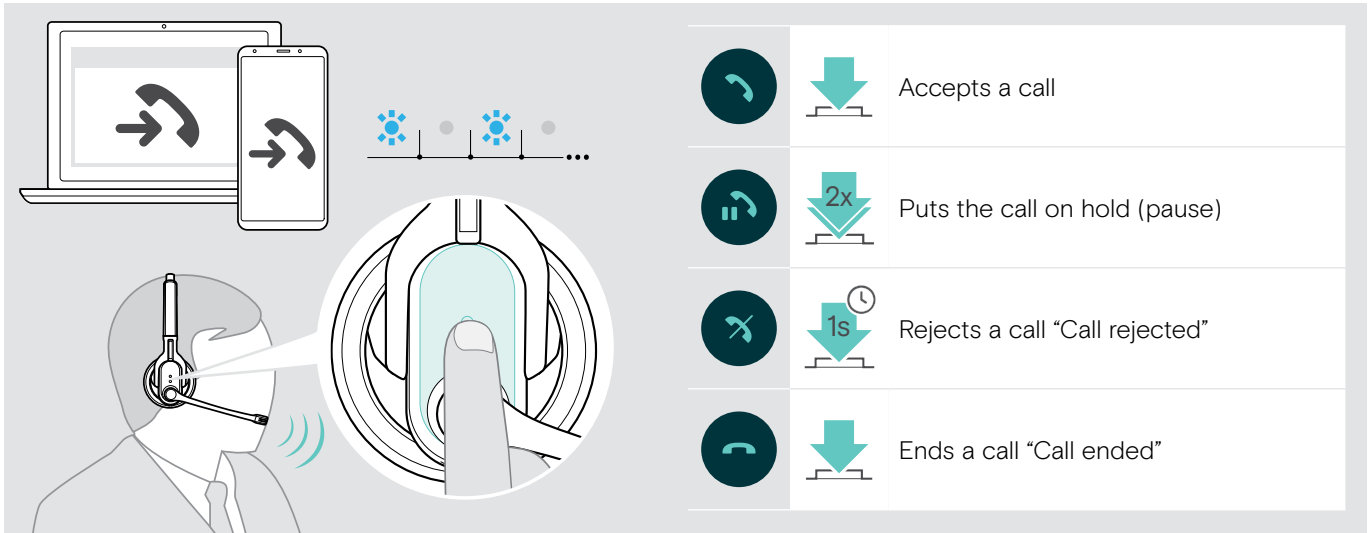

To accept a call while the **headset is being charged**:

- ▷ Take the headset from the magnetic holder of the charging cable. The headset switches on and the call is automatically accepted.
- ▷ Place the headset back into the magnetic holder to end the call and to continue charging the rechargeable battery.

To accept a call when the **headset is switched off**:

- ▷ Simply switch your headset on.

When you listen to media, the media reproduction is paused until you end the call. This function is not supported by all mobile phones.



When the voice prompts are disabled, you hear a beep in the headset.

Transferring the call to/from the headset

Once a connection is established, you can transfer the call to/from the headset.

▶ Press the multi-function button:

		Transfers a call from the headset to the mobile phone
		Transfers a call from the mobile phone to the headset

Redialing

The redialing function is only supported by Bluetooth devices with a “hands free profile” (HFP).

▶ Press the multi-function button:

		Redials the last number “Redialing”
		Cancels redialing “Redial cancelled”

Using the voice assistant

The last connected Bluetooth device will be used for voice assistant or voice dial.

▶ Press the multi-function button:

		Activates voice assistant
		Cancels voice assistant

▶ Say your voice command, e.g. “Call Jane”. The Bluetooth device dials Jane’s number.

Managing multiple calls

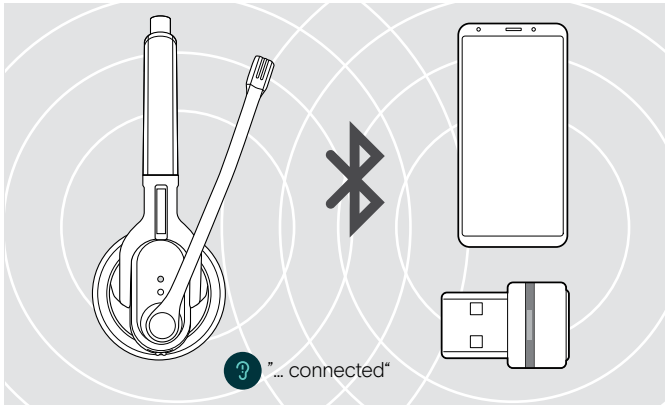

You can use the headset simultaneously with two connected Bluetooth devices (see page 9).

- ▷ Switch the headset on.
The headset automatically tries to establish a connection to the two last connected Bluetooth devices.

Managing two calls

You can manage two calls:

- from either two different Bluetooth devices or
- from one Bluetooth device.

If you receive a call during an active call:

- ▷ Press the multi-function button:

Active call	2nd incoming call	
		Accepts the incoming call and ends the active call
		Accepts the incoming call and puts an active call on hold (toggling - phone dependent)
		Rejects the incoming call and continues the active call

If you put an active call on hold (toggling):

- ▷ Press the multi-function button again:

		Ends the active call and makes the call on hold active (phone dependent)

Using headset and dongle with Microsoft® Teams

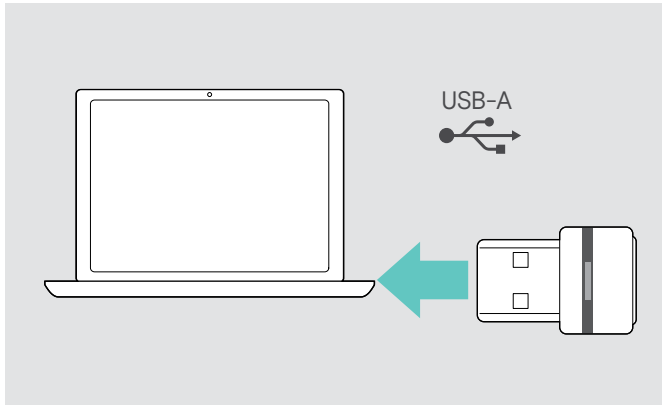

To use Microsoft Teams with the headset:

- ▶ Plug the dongle into the USB port of your computer – see page 9.
If Microsoft Teams is already running, the blue LED changes to purple automatically.

Invoking Microsoft® Teams and check notifications

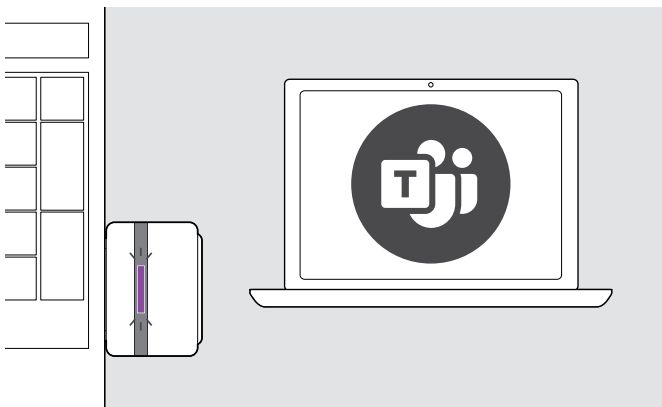

- ▶ Start Microsoft Teams on your computer. The dongle connects to Microsoft Teams and the LED blue LED changes to purple.

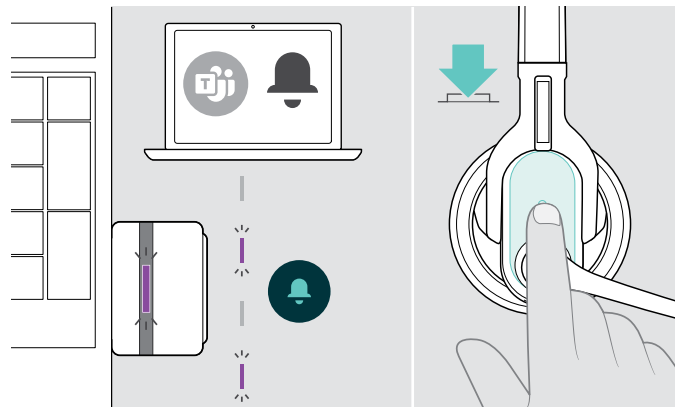

The LED pulses purple to indicate:

- Meeting Join Notification
- Voice Mail Notification
- Missed Call Notification

To check these Notifications on your screen:

- ▶ Press the multi-function button.

Activating / deactivating the voice prompts

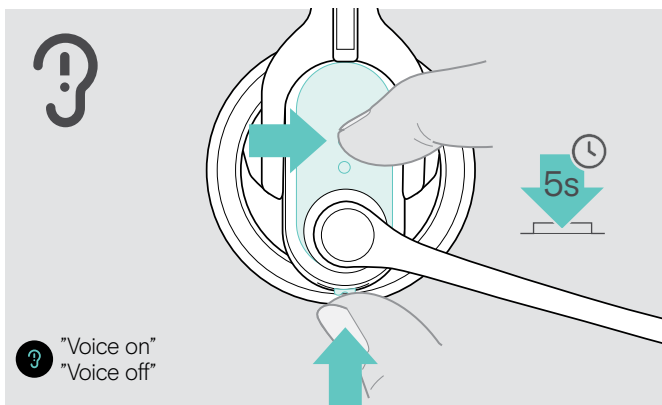

- ▶ Switch the headset on (see page 12).
- ▶ Simultaneously press and hold the headset's multi-function button and Audio button for 5 seconds. The voice prompts are now activated/deactivated and the voice prompt "Voice on" or "Voice off" is announced in the headset.

i If the voice prompts are deactivated, the headset emits beeps.

Activating / deactivating the room experience (MB Pro 2 only)

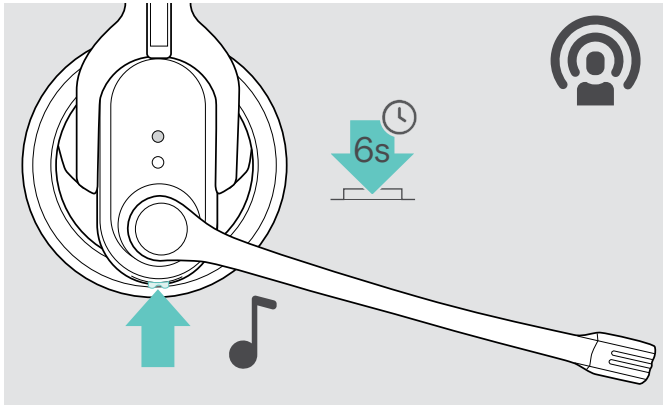

The room experience ensures enhanced call comfort when communicating. Your call partner's voice is reproduced very naturally, making long or many calls more comfortable and less tiring.

- ▶ Press the Audio button until you hear a confirmation beep.
The room experience is now activated or deactivated.

If you are out of the Bluetooth transmission range

Calling is only possible in the Bluetooth transmission range of the mobile phone/Bluetooth device. The transmission range largely depends on environmental conditions such as wall thickness, wall composition etc. With a free line of sight, the transmission range of most mobile phones and Bluetooth devices is up to 10 meters.

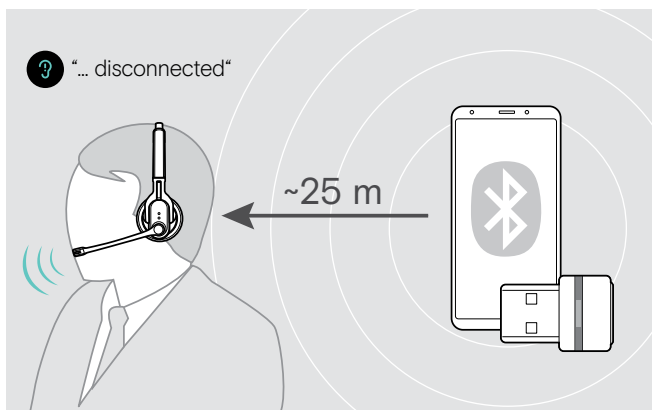

If the headset leaves the transmission range of the connected Bluetooth device during a call, one of the following voice prompts is announced in the headset:

- "Phone one disconnected" for the first mobile phone
- "Phone two disconnected" for the second mobile phone or
- "Dongle disconnected" for the Bluetooth dongle.

Dongle:

If you re-enter the Bluetooth transmission range, the connection is re-established and the voice prompt "Dongle connected" is announced in the headset.

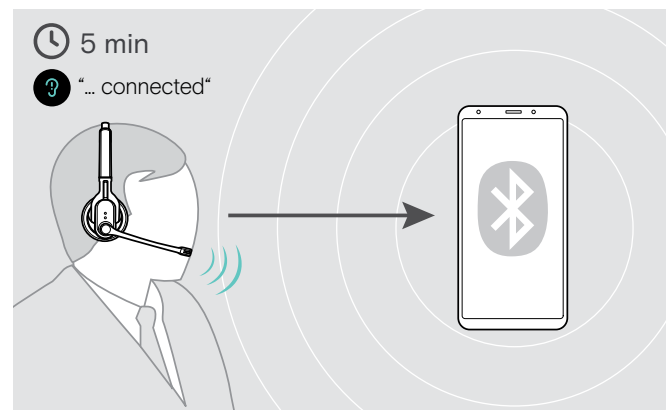

Mobile phone:

If you re-enter the Bluetooth transmission range **within 5 minutes**, the connection is re-established and the voice prompt "Phone one connected" or "Phone two connected" is announced in the headset.

If you spend **more than 5 minutes** outside the Bluetooth transmission range, the connection breaks down completely and you have to manually re-establish the connection.

To re-establish a connection to the mobile phone:

- ▶ Briefly press the multi-function button.
Once the connection is successfully re-established, one of the following voice prompts is announced in the headset:
 - "Phone one connected" for the first mobile phone
 - "Phone two connected" for the second mobile phone

Cleaning and maintaining the headset

CAUTION

Liquids can damage the electronics of the product!

Liquids entering the housing of the device can cause a short circuit and damage the electronics.

- ▷ Keep all liquids far away from the product.
- ▷ Do not use any cleansing agents or solvents.

Cleaning the headset and the headset charger

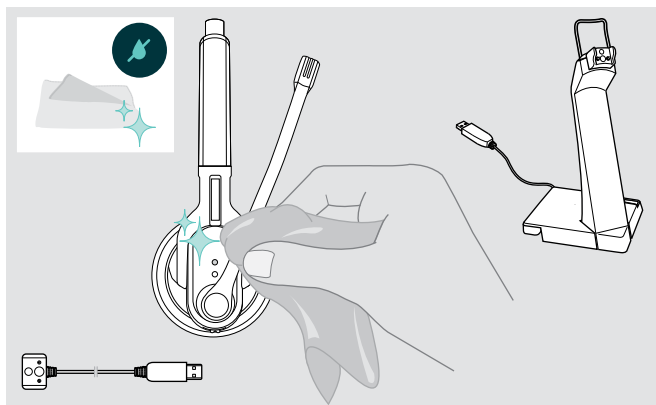

- ▷ Before cleaning, unplug the USB plug of the charging cable.
- ▷ Only use a dry and soft cloth to clean the product.

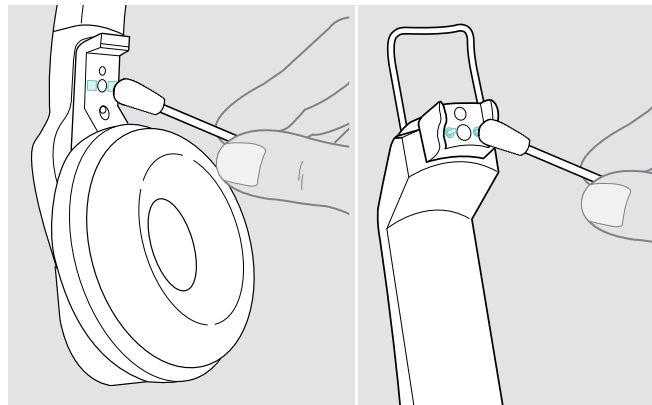

- ▷ Clean the charging contacts of the headset and the charging contacts of the headset charger from time to time using e.g. a cotton swab.

Replacing the ear pads

For reasons of hygiene, you should replace the ear pads from time to time. Spare ear pads are available from your EPOS partner.

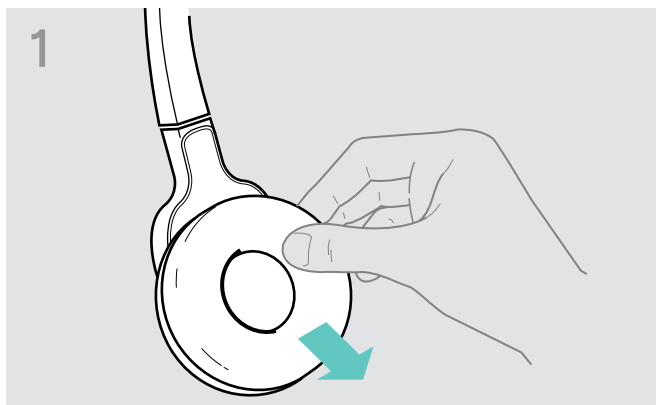

- ▷ Carefully remove the old ear pad from the ear cup.

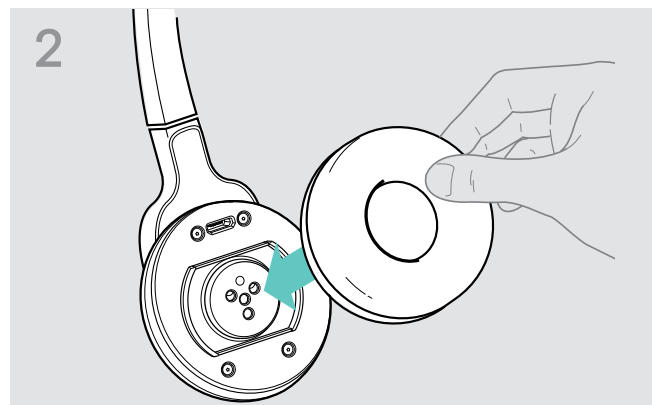

- ▷ Attach the new ear pad to the ear cup by pressing firmly around the ear pad.

Replacing the headset's rechargeable battery

CAUTION

Damage to the product due to improper handling!

The cables can be kinked or damaged if you open the battery compartment too jerkily.

- ▶ Carefully open the battery compartment and loosen the connector plug of the rechargeable battery.

Spare rechargeable batteries are available from your EPOS partner. Only use spare rechargeable batteries recommended by EPOS.

Replacing the rechargeable battery of the MB Pro 1 headset

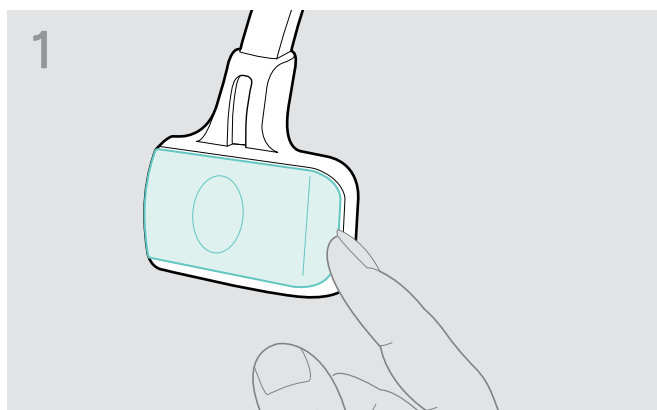

- ▶ Open the battery compartment cover.

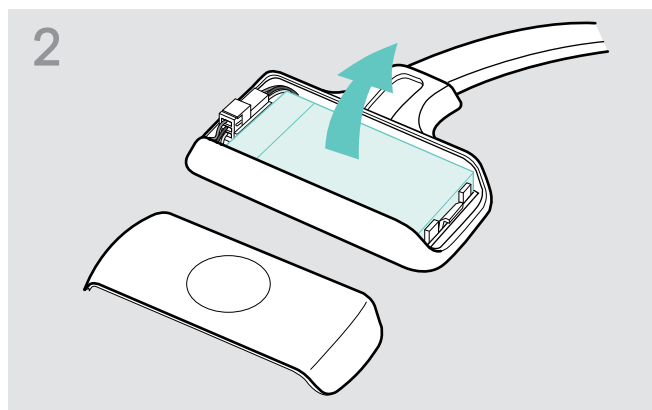

- ▶ Remove the rechargeable battery.
- ▶ Carefully loosen the connector plug of the rechargeable battery.

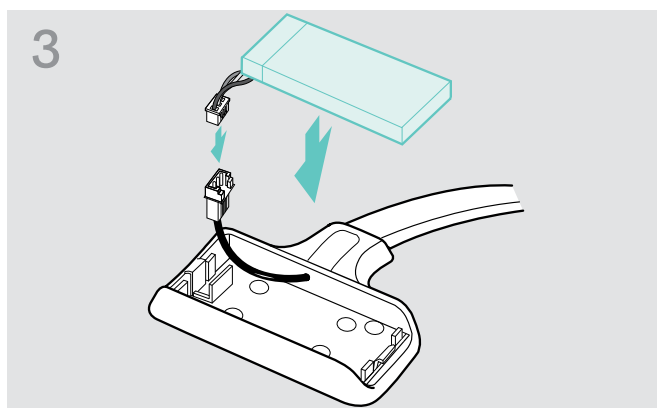

- ▶ Insert the connector plug of the new rechargeable battery into the connection socket. Observe correct orientation of the connector plug.

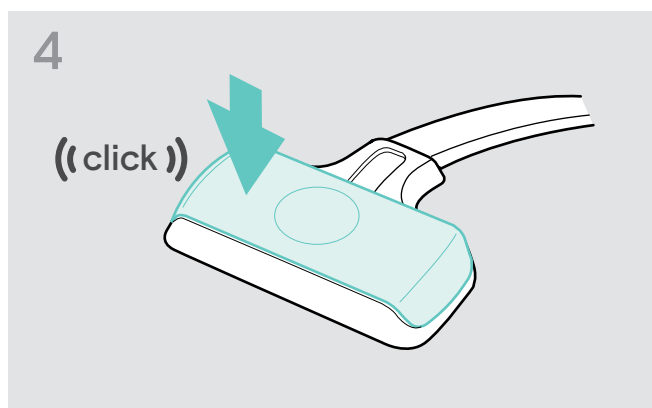

- ▶ Reattach the battery compartment cover.

Replacing the rechargeable battery of the MB Pro 2 headset

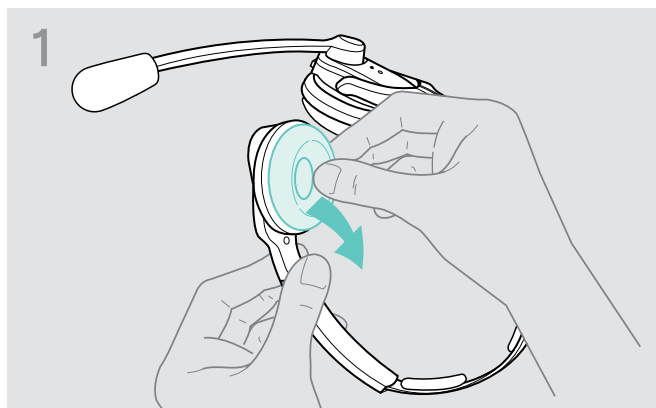

▷ Carefully remove the ear pad from the ear cup where the battery compartment is located.

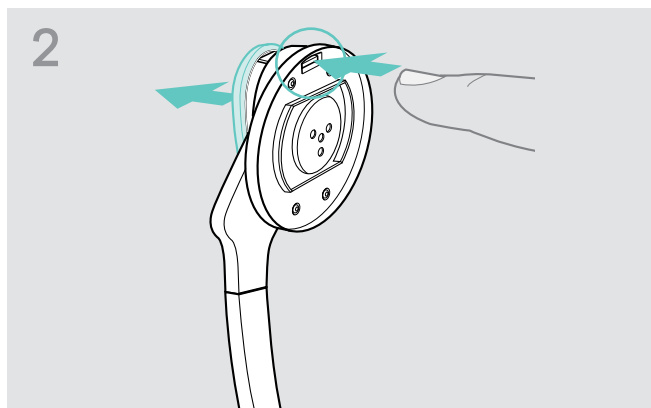

▷ Open the battery compartment.



▷ Remove the rechargeable battery and carefully loosen the connector plug of the rechargeable battery.

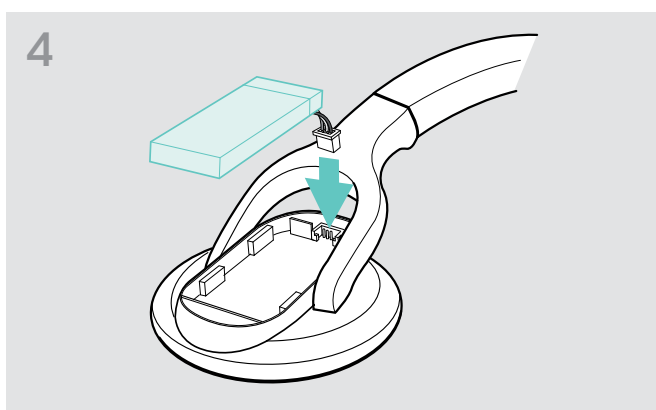

▷ Insert the connector plug of the new rechargeable battery into the connection socket. Observe correct orientation of the connector plug.

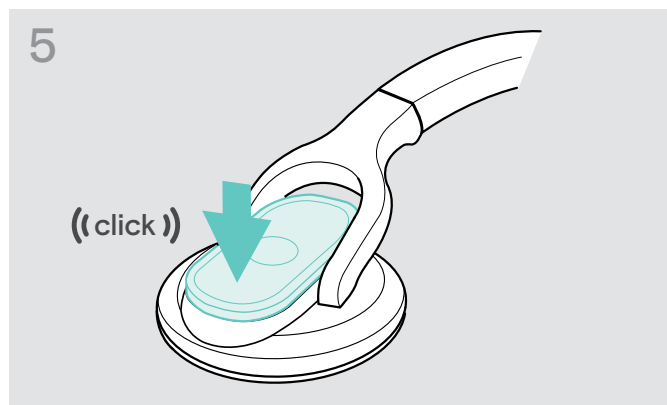

▷ Reattach the battery compartment cover.

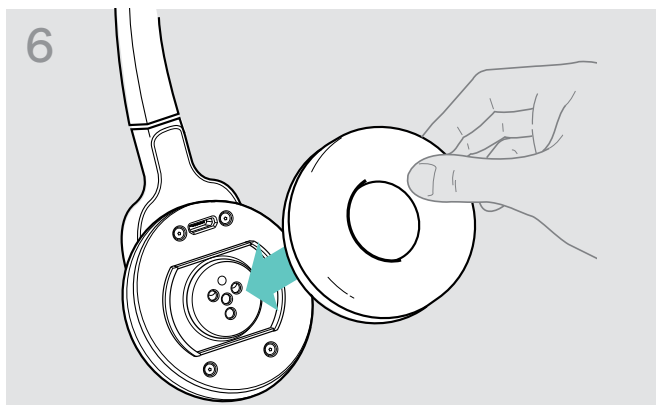

▷ Reattach the ear pad to the ear cup by pressing firmly around the ear pad.

Storing the headset

If you do not use the headset for extended periods of time:

- ▷ Charge the rechargeable battery every 3 months for about 1 hour.
- ▷ Store the headset in a clean and dry environment.

Updating the software of the product

You can update the software of your headset and Bluetooth dongle by using the free “EPOS Connect” PC software.

- ▷ Download “EPOS Connect” from www.eposaudio.com/connect.
- ▷ Install the PC software. To install the software, you need administrator rights on your computer. If necessary, contact your IT department.
- ▷ To update the software, connect only one product at a time.

Updating the software of the headset

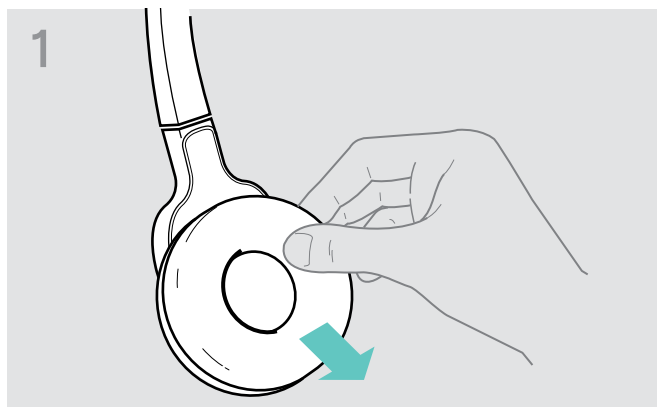

- ▷ Remove the ear pad from the ear cup where the microphone is located.

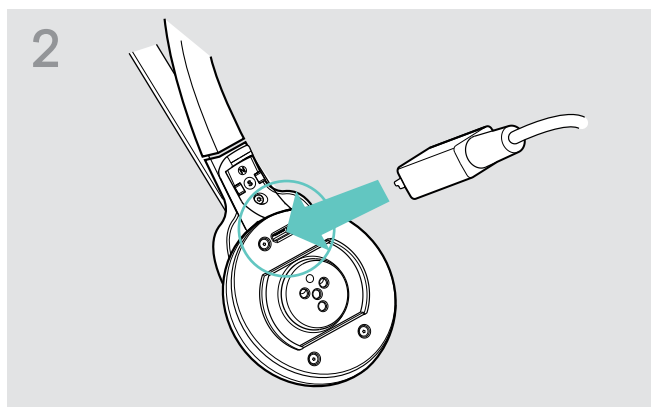

- ▷ Use a USB cable with micro USB plug to connect the headset to your computer.

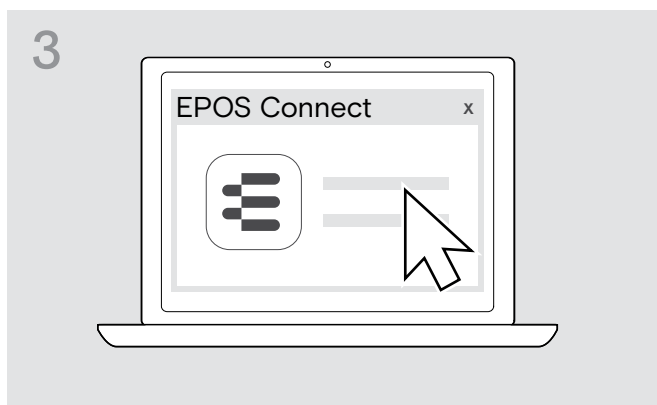

- ▷ Start “EPOS Connect”.
“EPOS Connect” compares the installed firmware version of the headset to the latest firmware version available for download. If your firmware needs to be updated, upgrade to the latest version according to the instructions of “EPOS Connect”.

Updating the software of the Bluetooth USB dongle

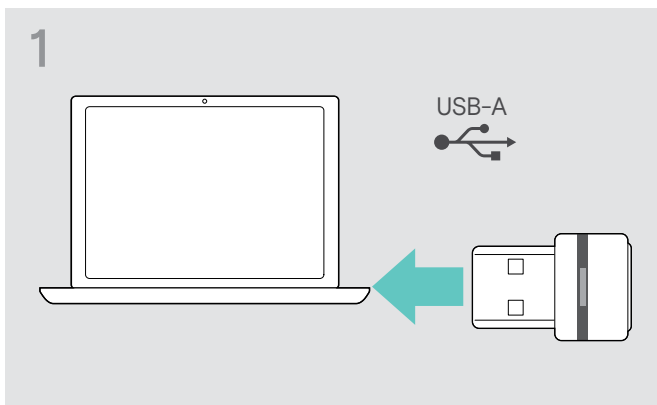

- ▷ Plug the Bluetooth USB dongle into the USB port of your PC.

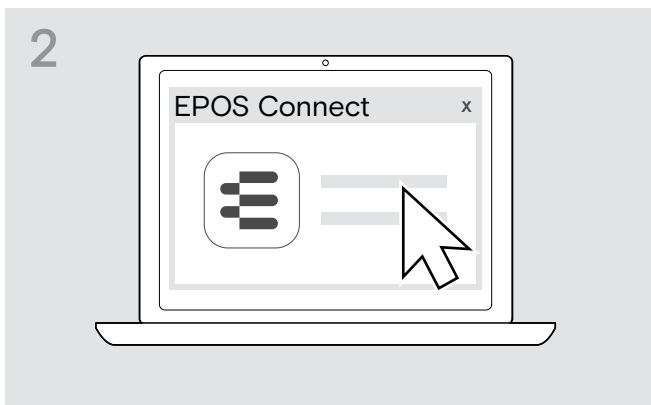

- ▷ Start “EPOS Connect”.
“EPOS Connect” compares the installed firmware version of the Bluetooth USB dongle to the latest firmware version available for download. Upgrade to the latest version according to the instructions of the “EPOS Connect”.

If a problem occurs ...

Problem	Possible cause	Solution	Page
Headset cannot be switched on	The rechargeable battery is flat	▷ Recharge the rechargeable battery.	8
No audio signal	The headset is not paired with the mobile phone	▷ Check if the headset is paired. If necessary, pair the headset again.	9
	The volume is adjusted too low	▷ Increase the volume.	15
	The headset is switched off	▷ Switch the headset on.	12
Headset cannot be paired	The pairing does not work	▷ Check if your Bluetooth device supports the HF or HS profile.	-
	The mobile phone is switched off	▷ Switch your mobile phone on.	-
	Bluetooth is deactivated on the mobile phone	▷ Activate Bluetooth on your mobile phone.	-
No voice prompts announced (beeps only)	The voice prompts are deactivated	▷ Activate the voice prompts.	15
Headset does not react to any button press	The operation of the headset is faulty	▷ Reset the headset to the factory default settings.	24

If a problem occurs that is not listed in the above table or if the problem cannot be solved with the proposed solutions, please contact your local EPOS partner for assistance.

To find an EPOS partner in your country, search at www.eposaudio.com.

Restoring factory default settings (Reset)

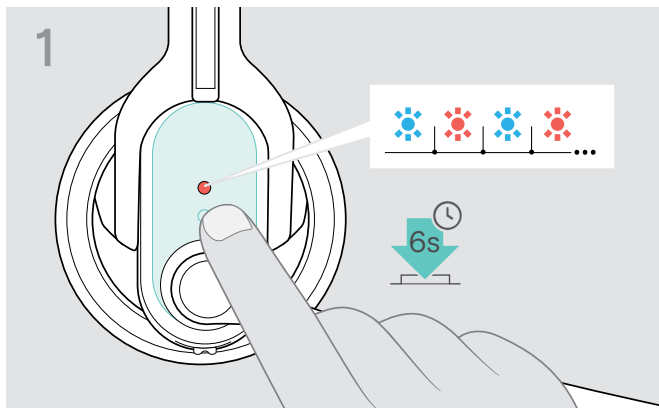

- ▷ Switch the headset off (see page 12).
- ▷ Keep the multi-function button pressed until the LED alternately flashes blue and red.

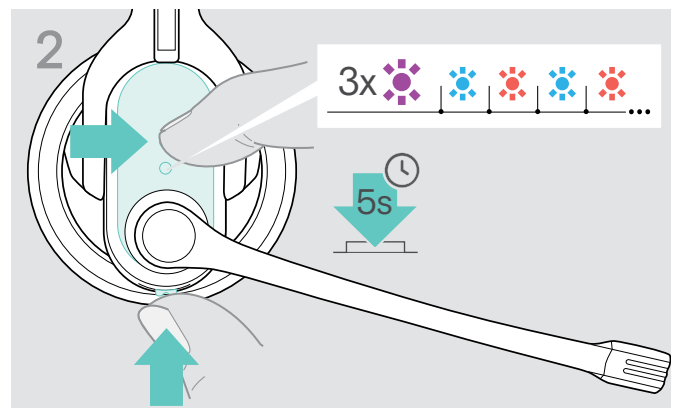

- ▷ Simultaneously press and hold the headset's multi-function button and Audio button for 5 seconds. The LED flashes 3 times purple and then alternately blue and red. The headset tries to pair with Bluetooth devices (see page 9).

Specifications

IMPACT MB Pro 1 | MB Pro 2

Dimensions (W x H x D)	170 x 175 x 55 mm
Weight	MB Pro 1: approx. 64 g MB Pro 2: approx. 83 g
Standby time	up to 19 days
Talk time	up to 15 hours
Charging time of rechargeable battery	2 hours 30 minutes
Rechargeable battery (built-in)	Lithium Polymer; 3.7 V; 205 mA
Speaker type	dynamic, neodymium magnet
Speaker frequency response	150 – 6,800 Hz (wideband) 200 – 3,400 Hz (narrowband) 150 – 15,000 Hz (A2DP/media)
Sound pressure level	max. 118 dB SPL (ERP)
Microphone type	Noise cancelling electret condenser microphone
Microphone frequency response	150 – 6,800 Hz (wideband) 200 – 3,400 Hz (narrowband)

BTD 800 USB dongle

Dimensions (W x H x D)	22 x 16 x 6 mm
Weight	2 g

IMPACT MB Pro 1 | IMPACT MB Pro 2 | BTD 800 USB

Operating temperature range	+10°C (+50°F) to +40°C (+104°F)
Operating relative humidity	20 to 85 %, non-condensing
Storage temperature range	-20°C (-4°F) to +60°C (140°F)
Storage relative humidity	10 to 95 %, non-condensing

Bluetooth

Bluetooth	version 4.0/class 1
Range	up to 25 m (device-dependent)
Transmission frequency	2,402 MHz to 2,480 MHz
Profiles	HSP (v1.2), HFP (v1.6), A2DP (v1.2)
Output power of headset	9 dBm / 7.90 mW
Output power of BTD 800 USB	8 dBm / 6.30 mW
Typical sensitivity of headset	-89 dBm
Typical sensitivity of BTD 800	-89 dBm

Trademarks

The Bluetooth word mark and logos are registered trademarks owned by Bluetooth SIG, Inc. and any use of such marks by DSEA A/S is under license.

EPOS | SENNHEISER

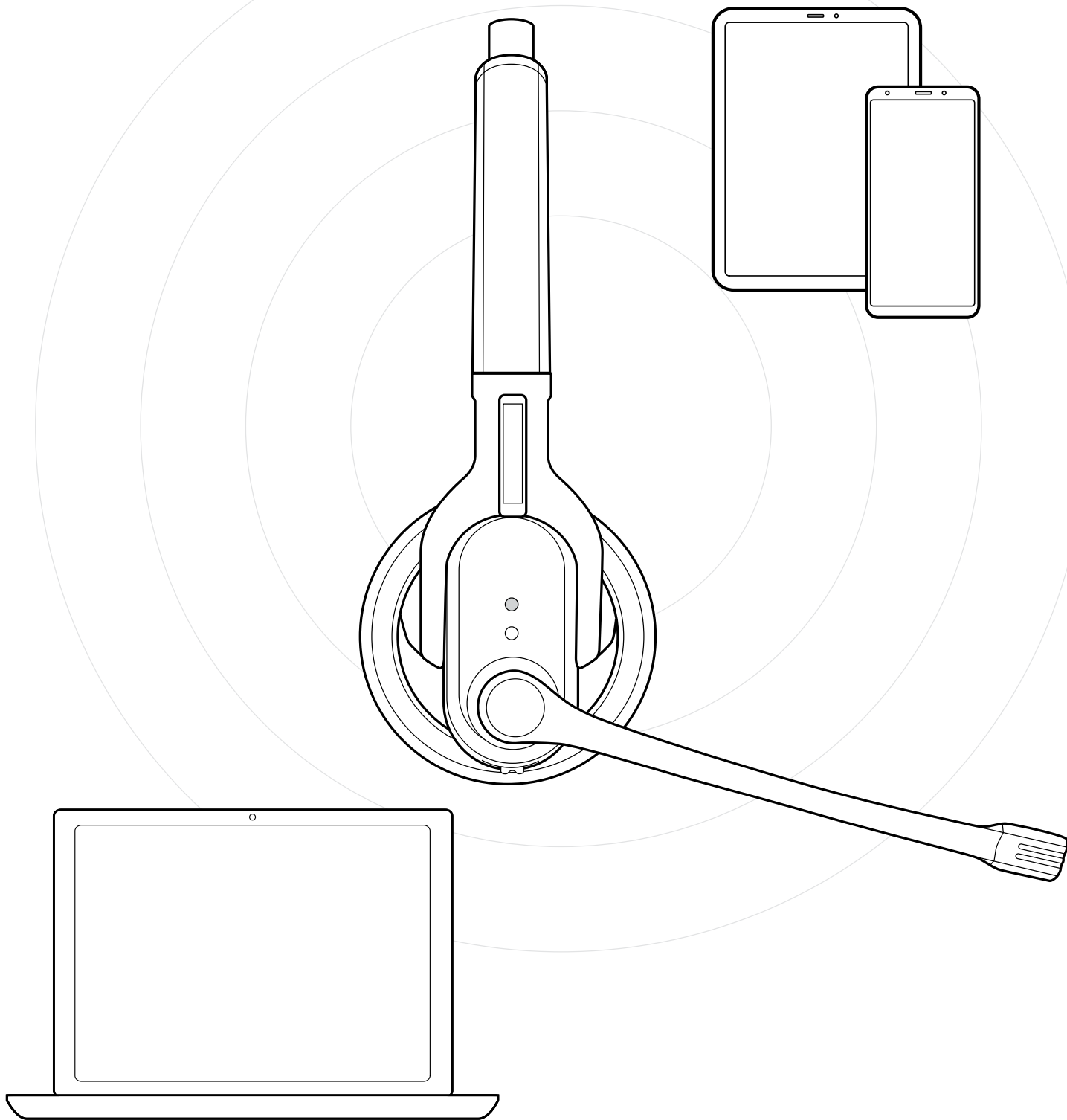

DSEA A/S

Kongebakken 9, DK-2765 Smørum, Denmark
www.eposaudio.com