

EPOS

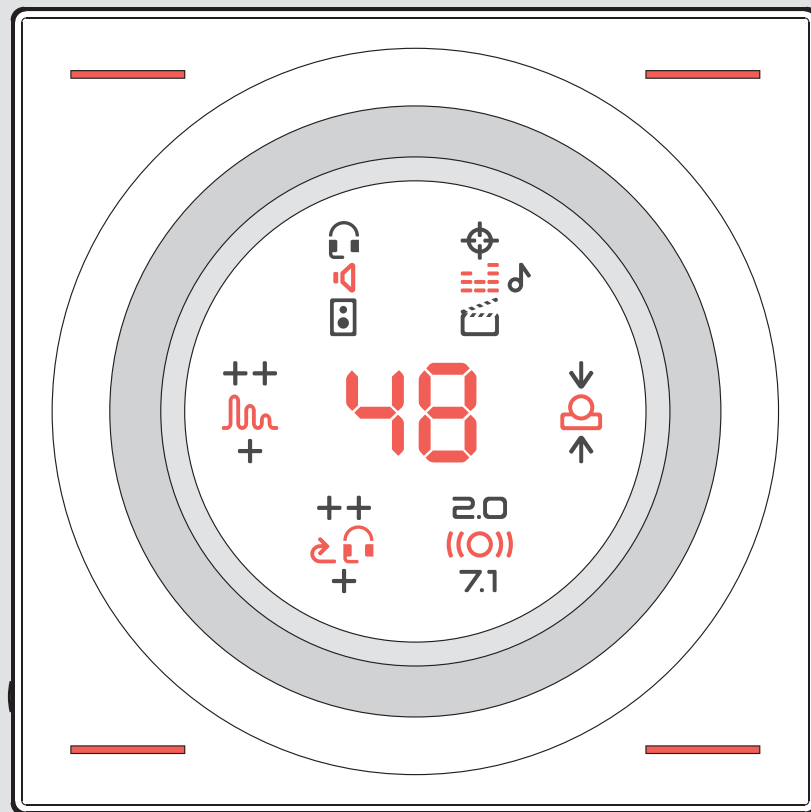

GSX 1000 2nd edition

外置声卡

使用说明书

1 供货范围

5 更改设置

通过“音量旋钮”或电脑设置音量
设置聊天音量
激活显示屏
在耳机与扬声器之间切换
选择均衡器设置
设置前方或后方虚拟增益
选择立体声或7.1虚拟立体声
调整侧音
调整混响(环境)

2 产品总览

6 保存并加载设置

当前设置将会自动保存
将设置保存为预设:最多为4个 - 每个角1个
加载4个预设中的1个

3 连接产品

连接电脑
连接扬声器

7 使用巡回赛模式

4 安装产品

调整电脑的音频设置
调整Mac的音频设置

8 清洁产品/恢复出厂设置

GSX 1000 2nd edition是公司发展历程中的全新里程碑式产品,带来游戏领域中沉浸式的音频体验,同时您可以自主控制,以获得所需的准确音效体验。

EPOS虚拟环绕算法是8年来对高级HRTF算法的深入研究和无数工时的成果,从而创造出我们认为当今市面上卓越的虚拟环绕声。

无论您的目标是更加身临其境的感受网络世界,还是在第一人称射击游戏中获得重要优势,GSX 1000 2nd edition将提供出色的游戏音效体验。

虽然GSX 1000 2nd edition的设置非常简单,无需安装驱动,但我们仍然建议您抽出一些时间浏览本说明书,以了解您所购买产品的全部威力。

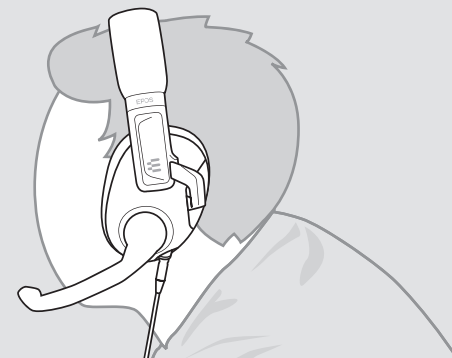

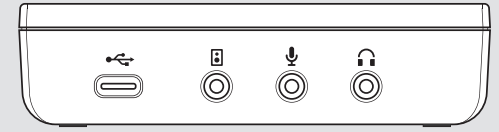
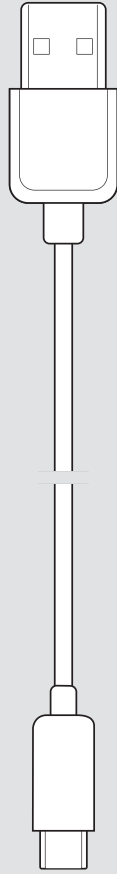
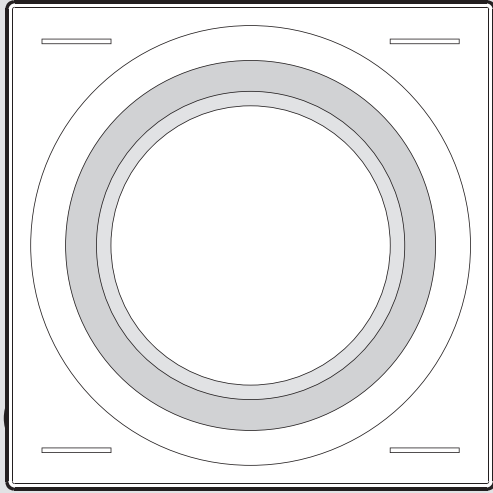

后侧

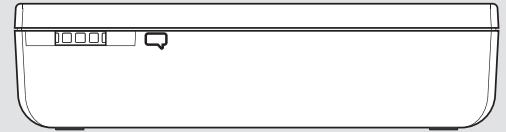

右侧

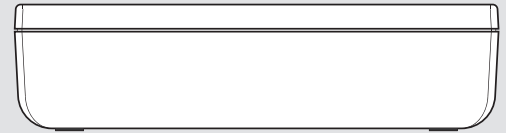

左侧

音量旋钮

保存设置和加载预设

显示屏和触摸控制面板

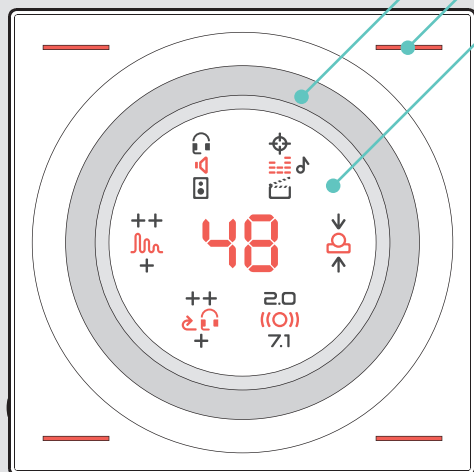

48

音量 0-99

在音响系统之间切换：
耳机或扬声器均衡器设置：
关闭、音乐、故事或电子竞技环绕放大：
前方、后方或中性音效模式：
立体声或 7.1 声道环绕声侧音音量：
++ 高、+ 低或中性混响(环境)：
++ 开放世界、
+ 密闭空间或中性

USB-C 接口

3.5 mm 输出插口

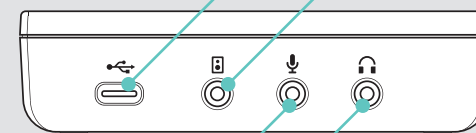

话筒插口

耳机插口

音量旋钮聊天



连接耳机

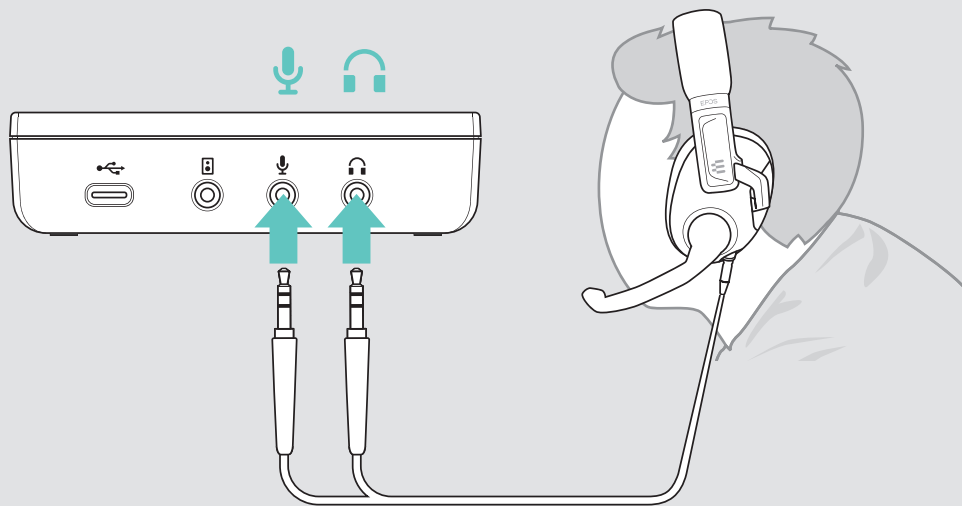

连接电脑

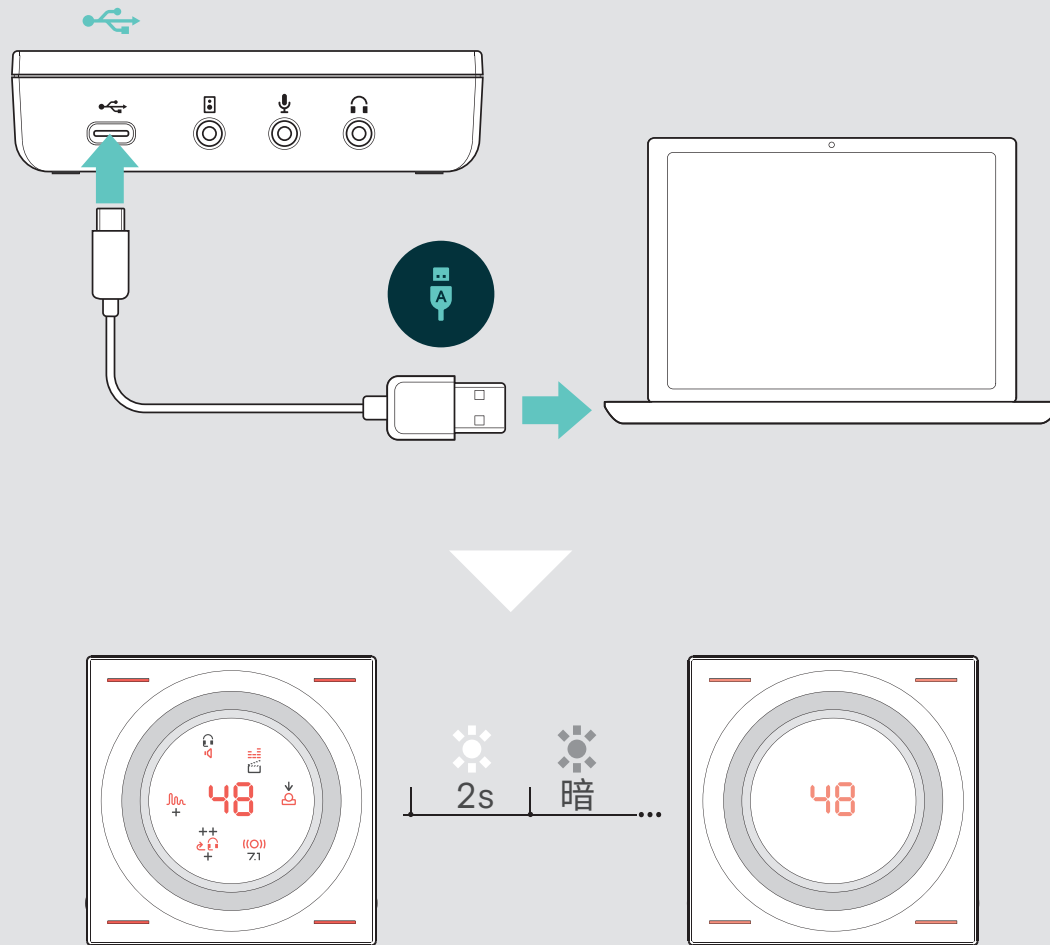

将耳机跟电脑连接起来

连接扬声器

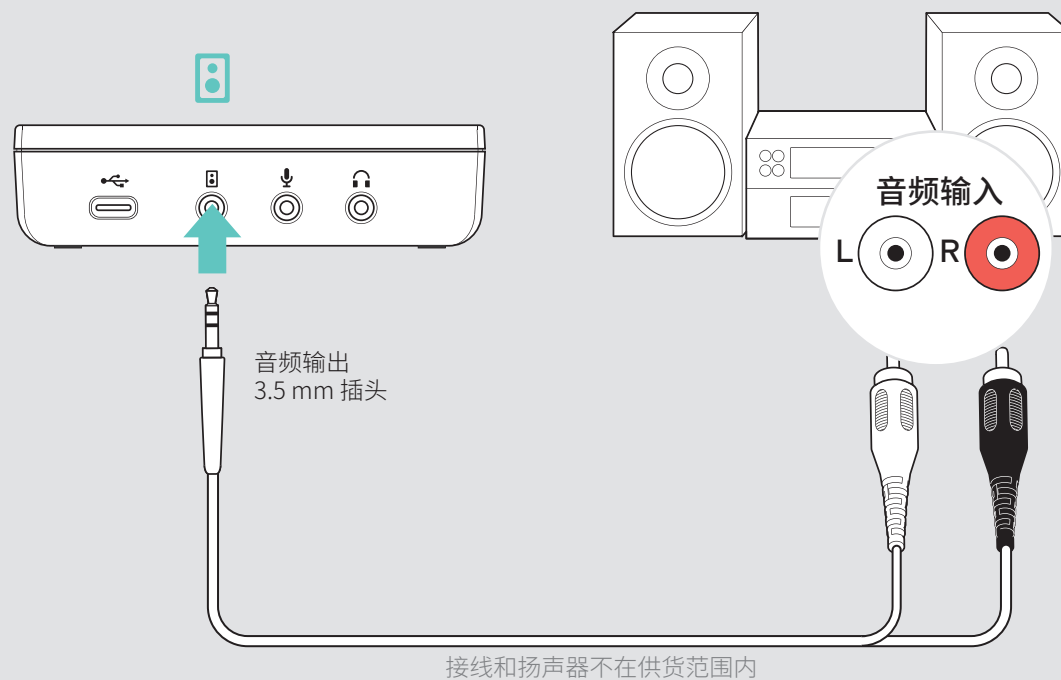

更改音频设置:PC

有关特定信息和固件更新，
请访问

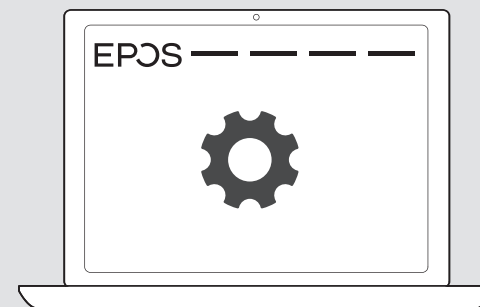

www.eposaudio.com/gaming

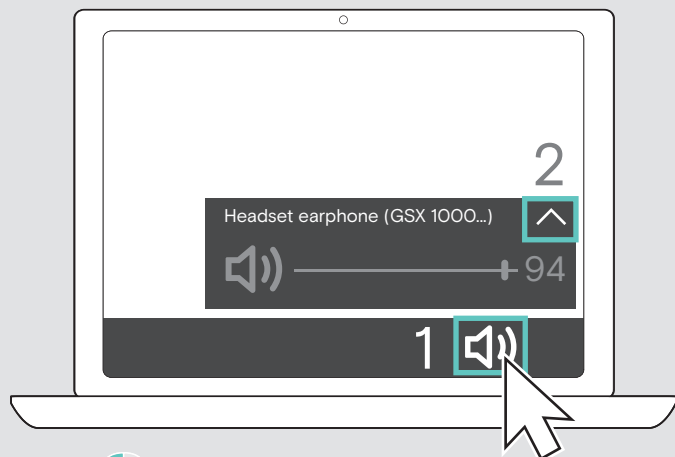
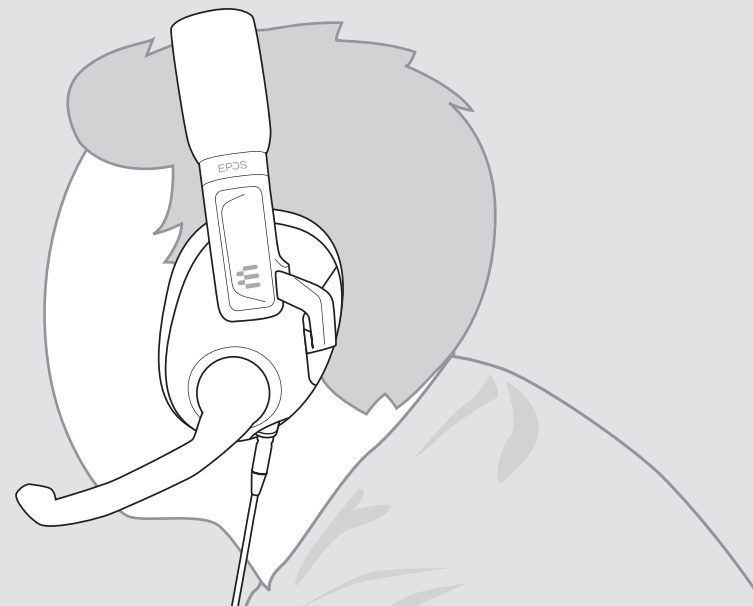

1. 单击音频图标。
2. 单击 ^ 图标。

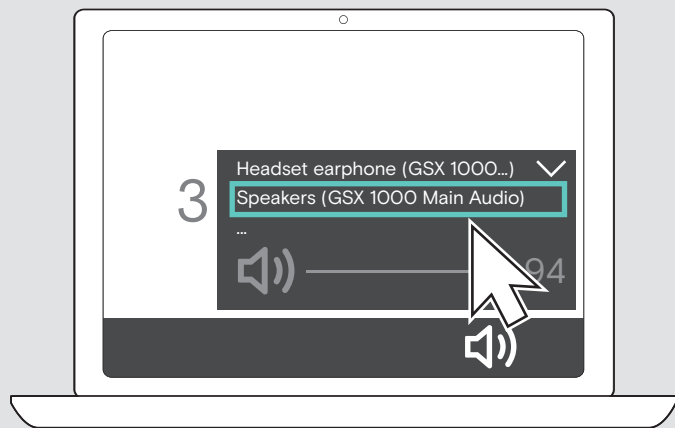

3. 选择“扬声器 GSX 1000 主音频”
Speakers (GSX 1000 Main Audio)。

更改音频设置: Mac

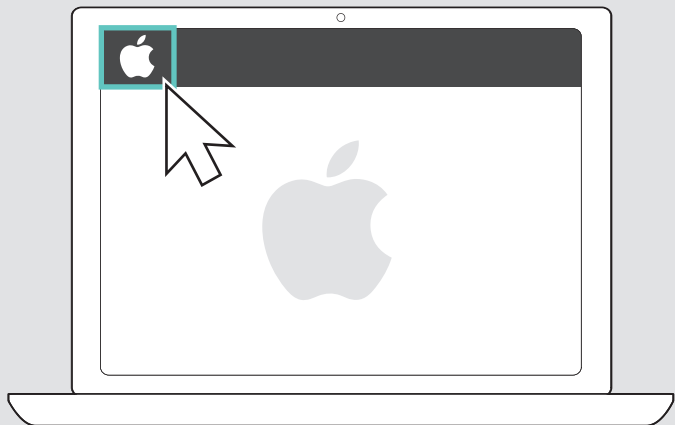

1. 单击 Apple 图标。
选择“系统偏好...”(System Preferences...)

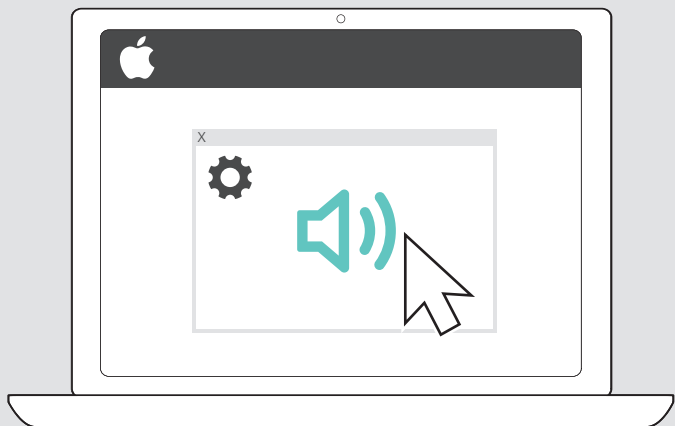

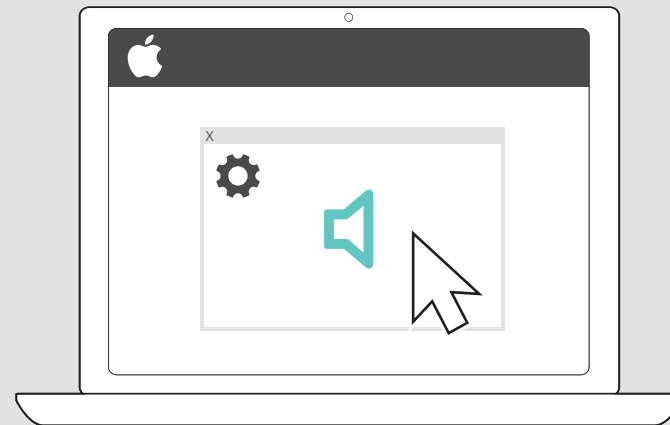

2. 选择“声音”(Sound)。

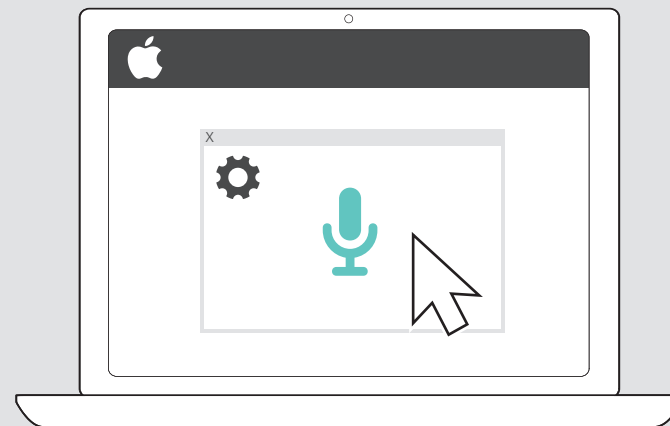

3. 选择“输出”(Output) 选项卡 >
“GSX... Main Audio”。

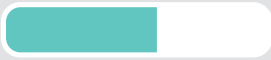

4. 选择“输入”(Input) 选项卡 >
“GSX... Communication Audio”。

音量-    音量+

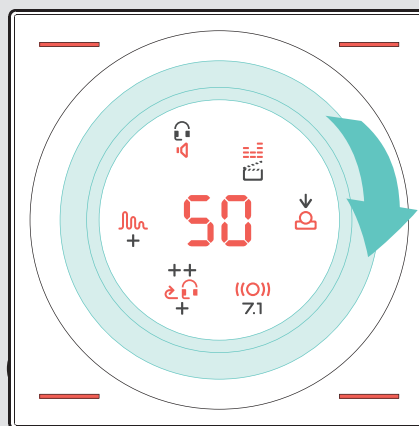
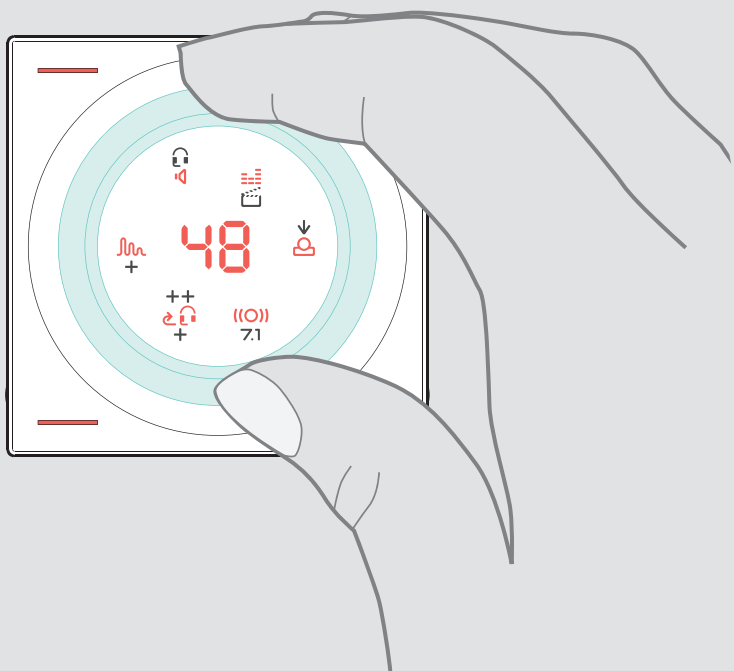

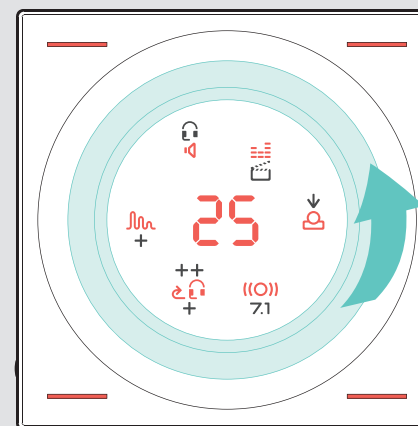

音量+



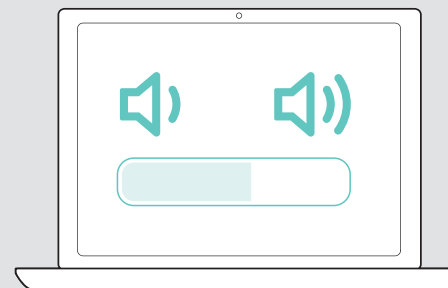

音量-

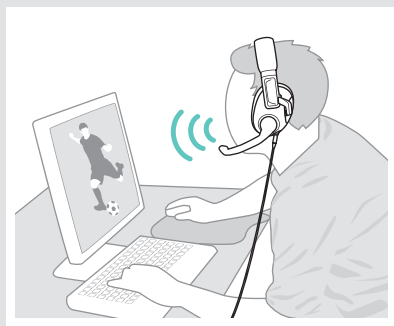

设置聊天音量

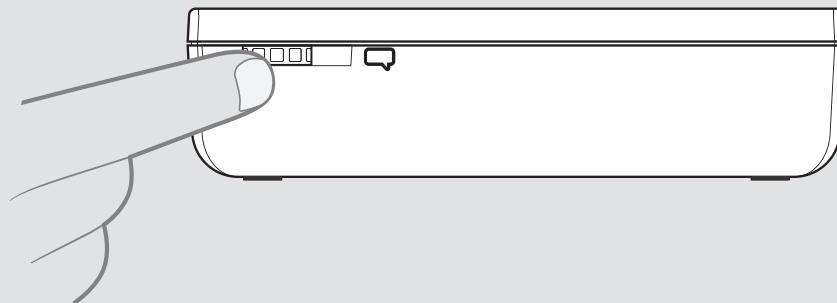

音量-    音量+



靠近以激活显示屏

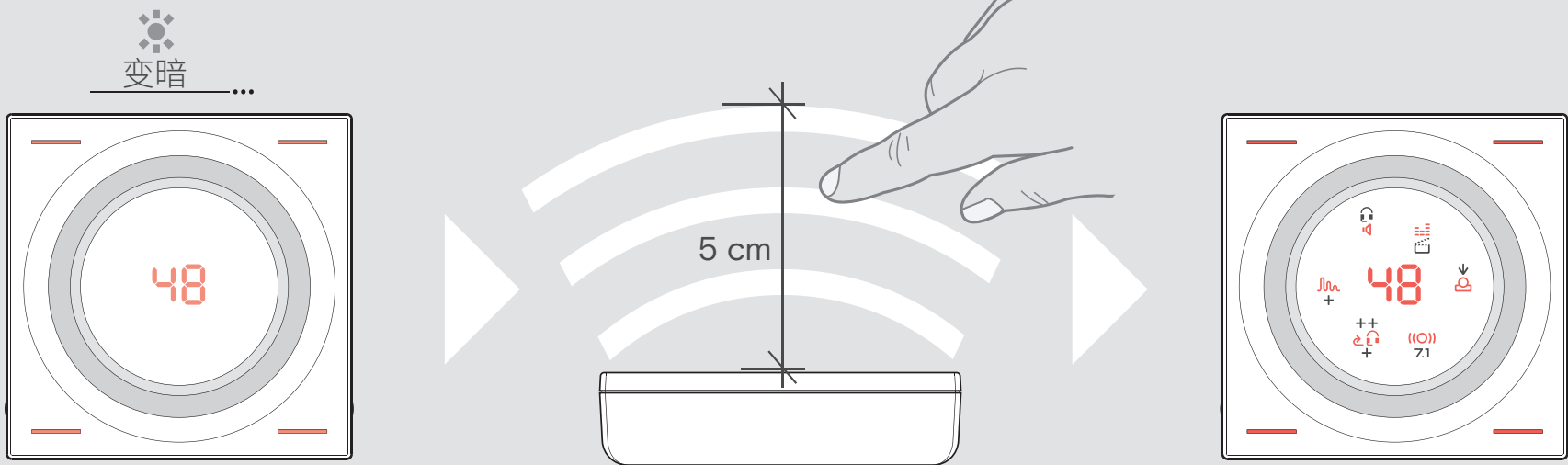

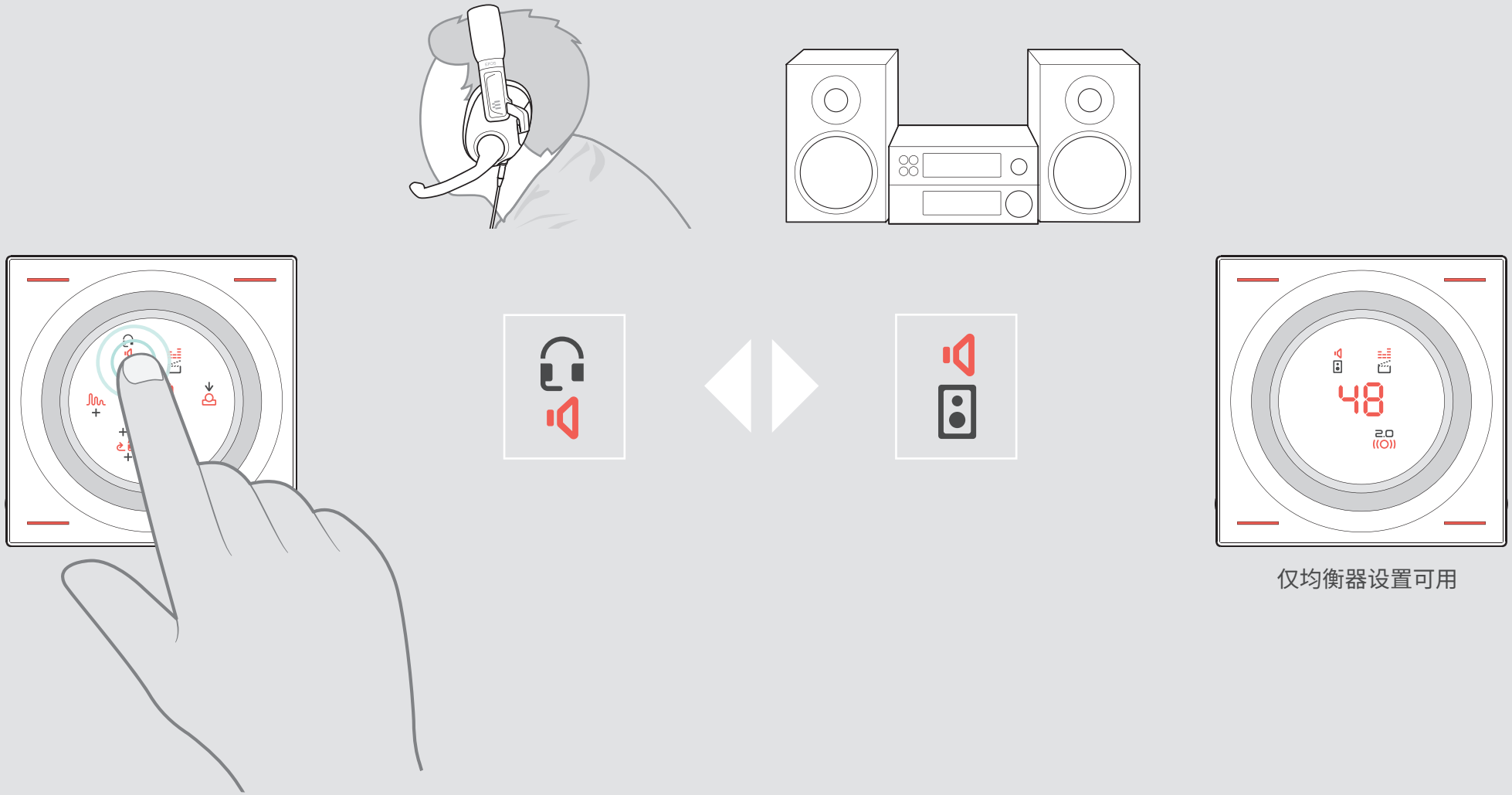

在耳机与扬声器之间切换

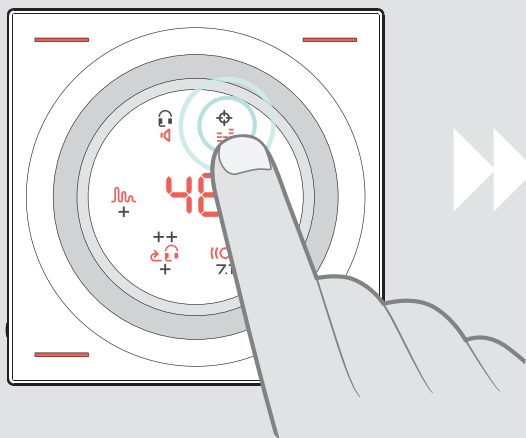

电子竞技

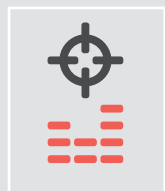

音乐



故事



无均衡器

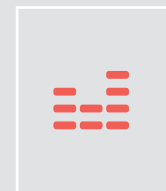



设置前方或后方虚拟增益

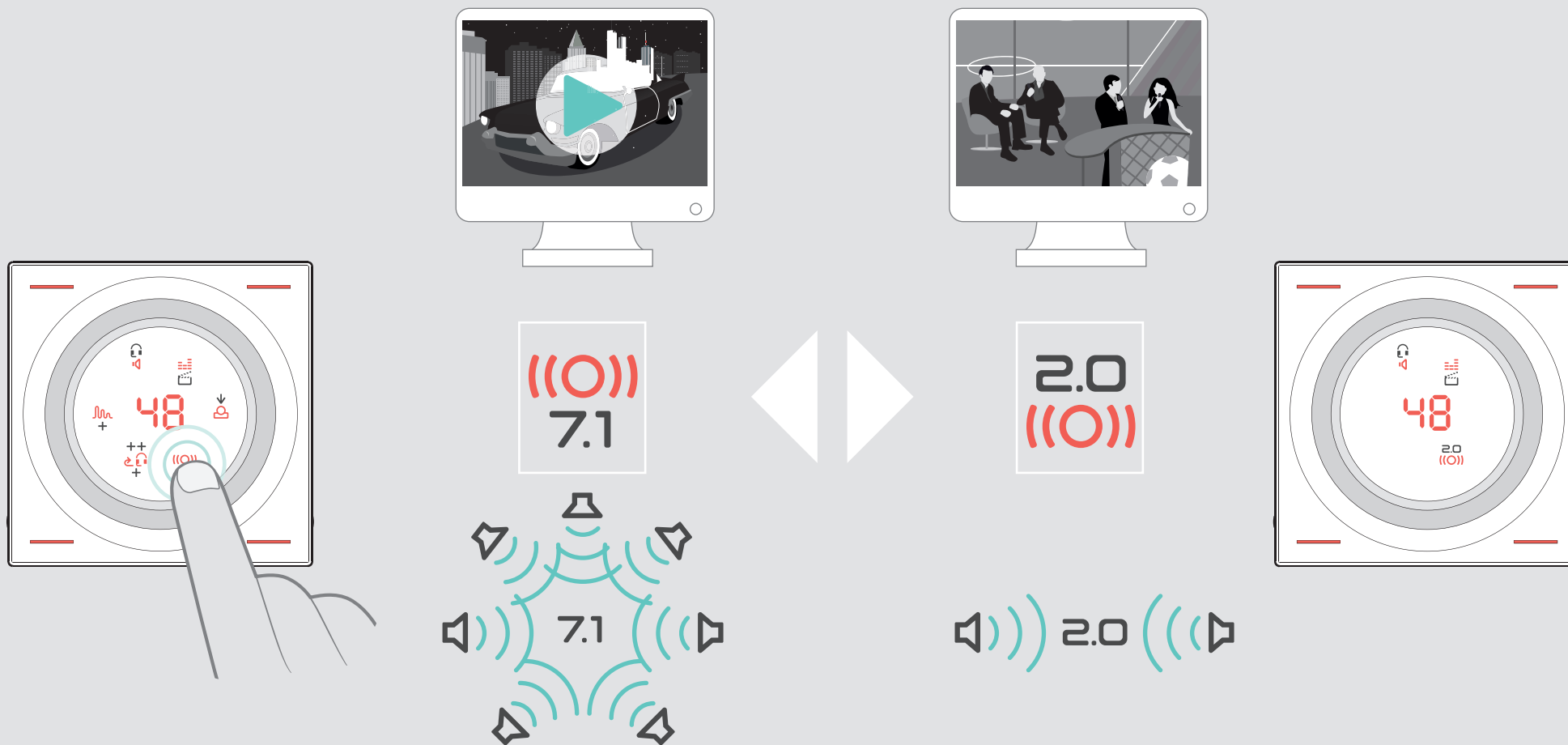

适用于支持 7.1 和 5.1 声道环绕声的电影和游戏。

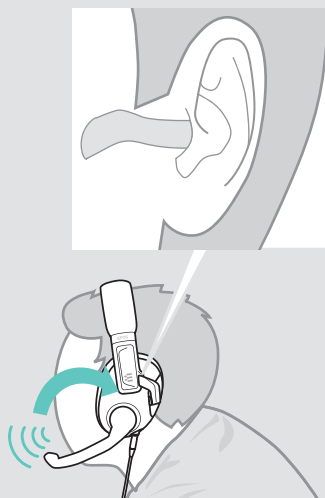
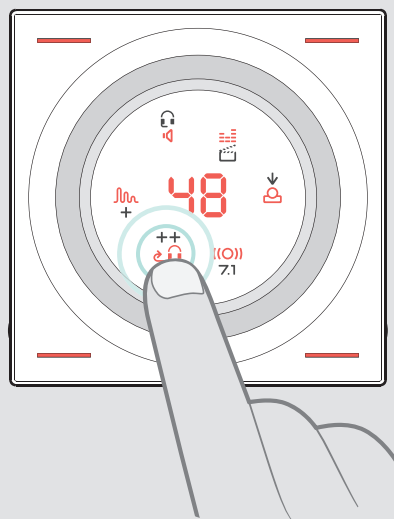

无侧音

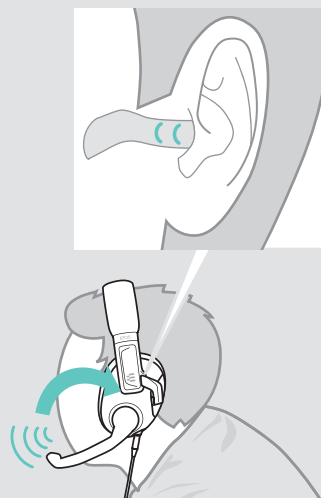

+ 适用于低侧音
建议用于开放式耳
机和部分贴耳式耳机。

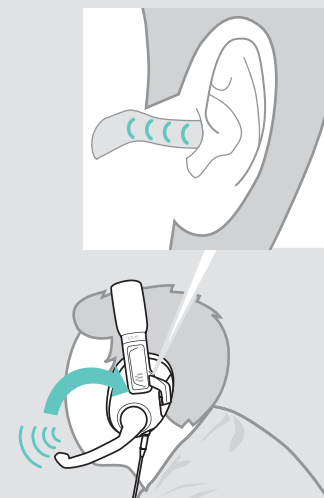

++ 适用于高侧音
建议用于封闭包耳
式耳机或入耳式耳机。



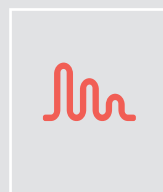
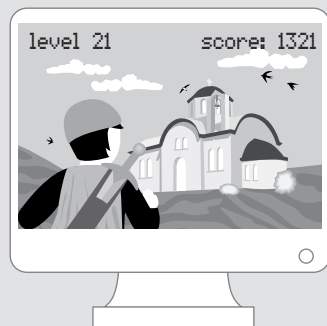
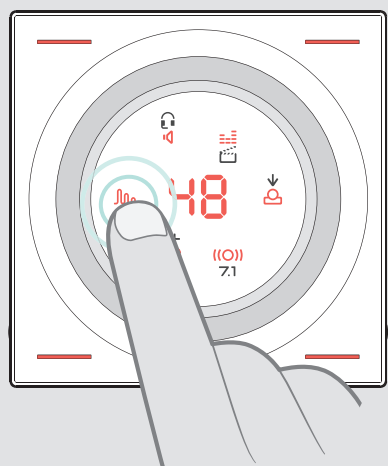

环境适用于
超精确音效
建议用于最精
确的声音重放。

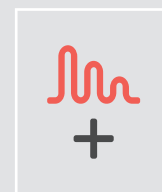

环境
+ 适用于密闭空间
建议用于半
开放世界游戏。

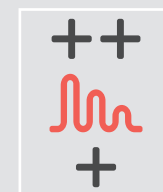
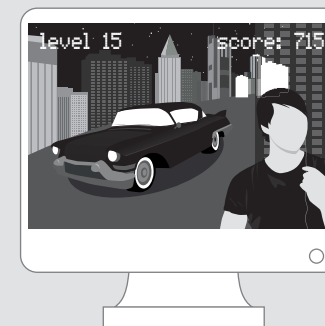

环境
++ 适用于开放世界
建议用于开
放世界游戏。



计算机关和开:保存和加载最新设置

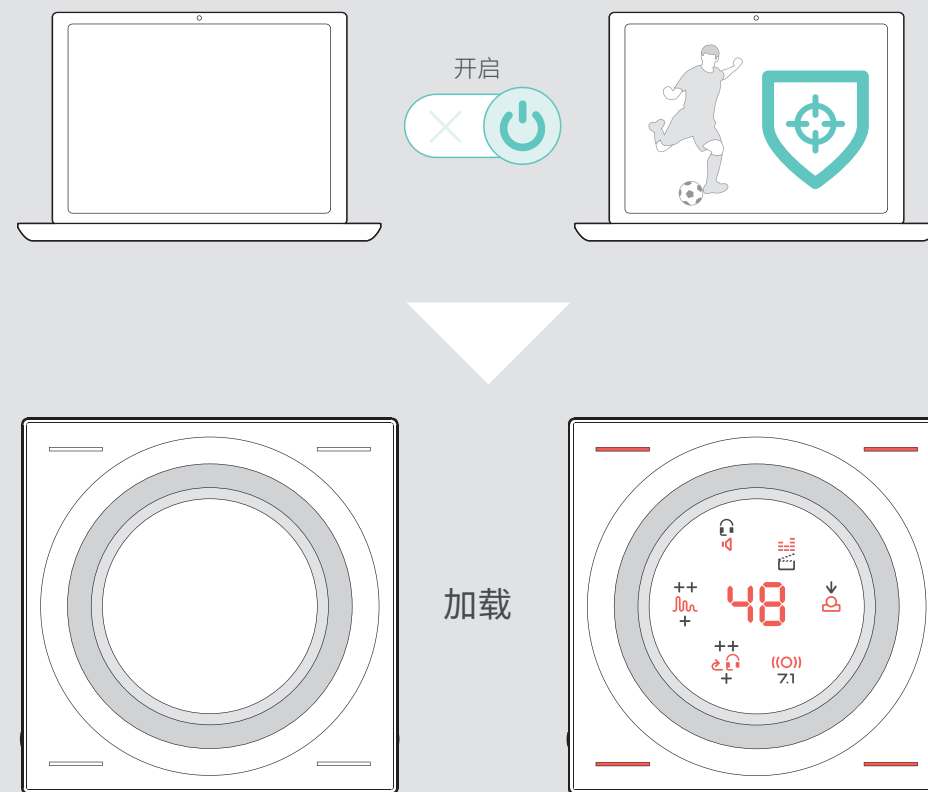
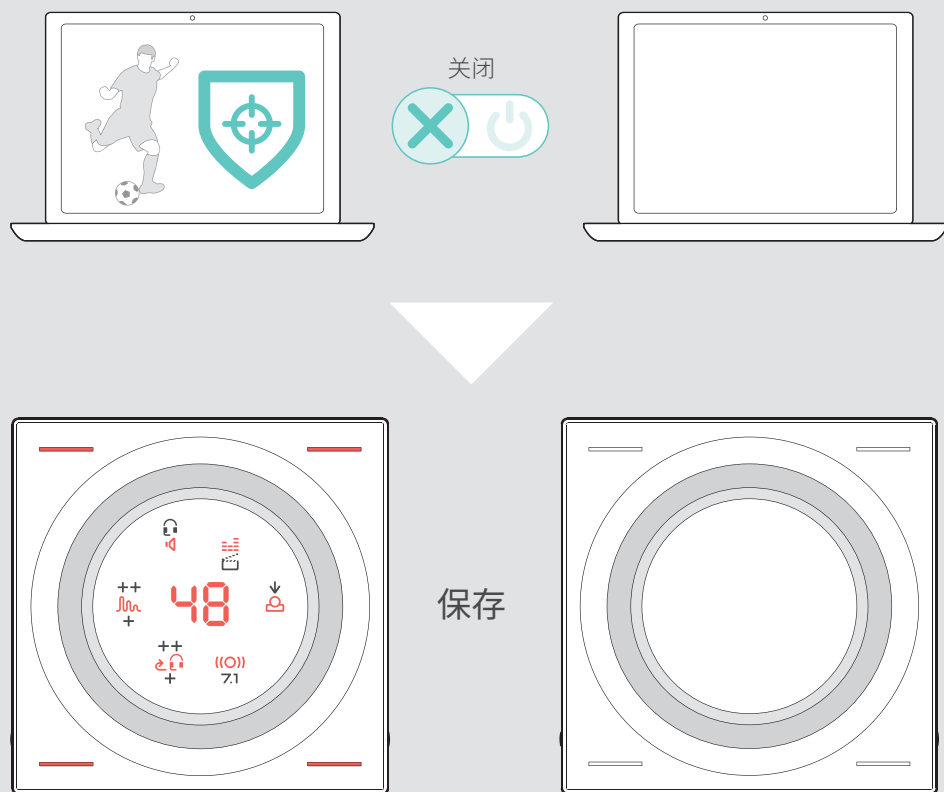

触摸并按住一个键, 以将设置保存为预设

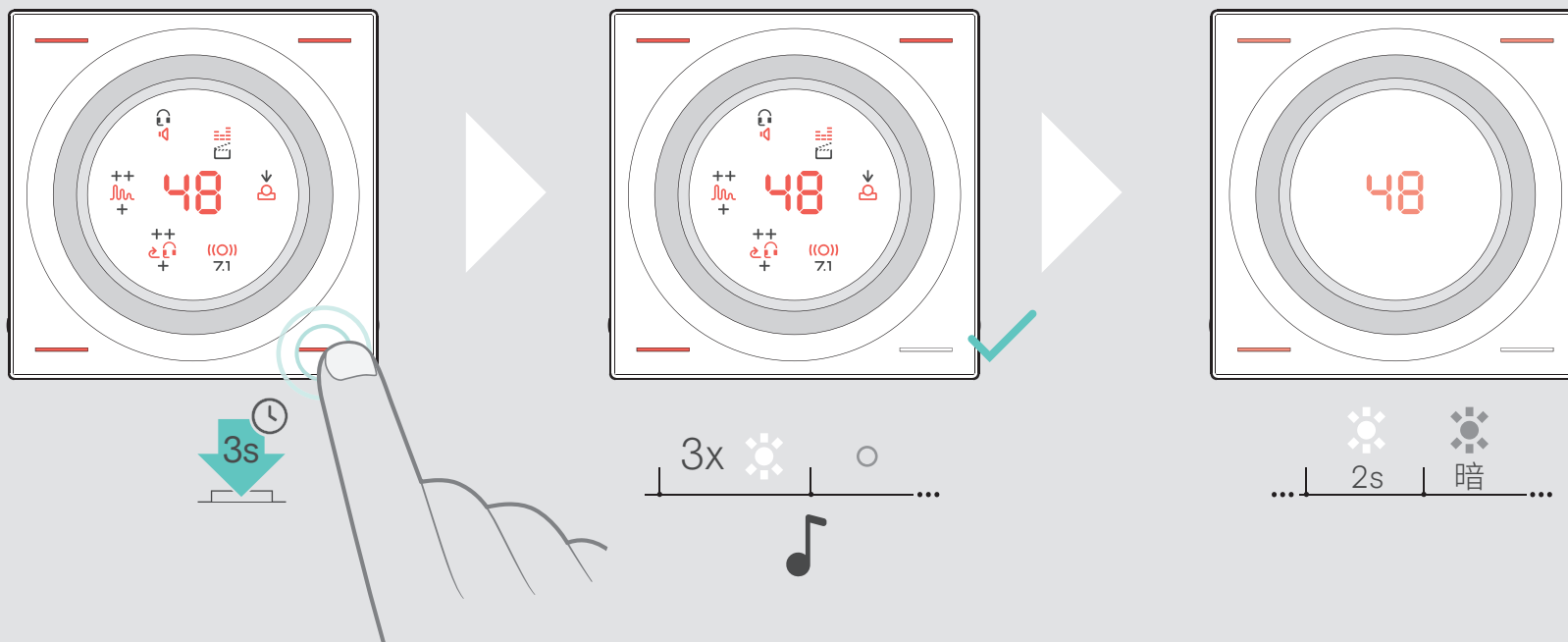

触摸一个键, 以加载预设

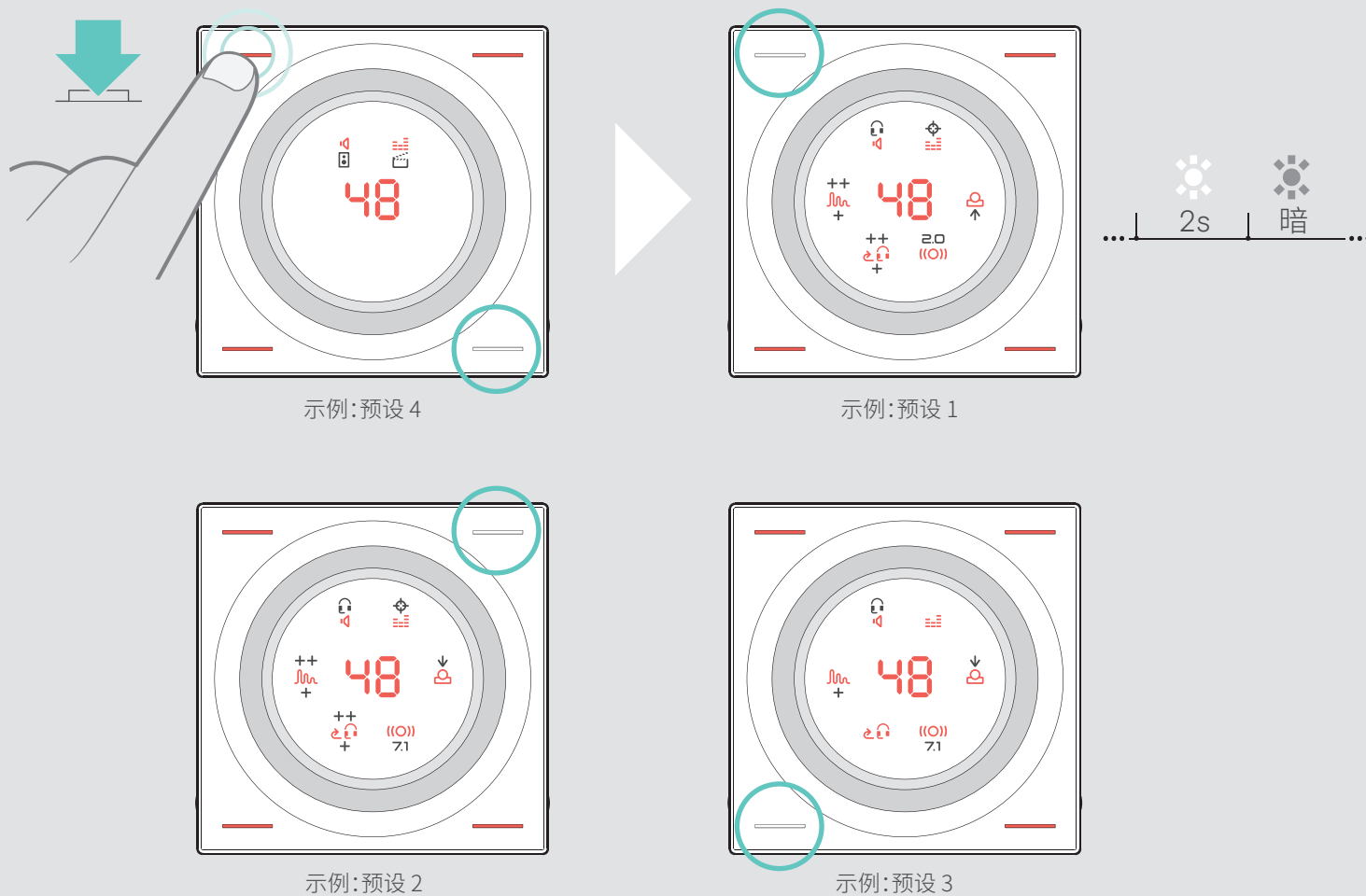

更改设置: 所有预设均为红色

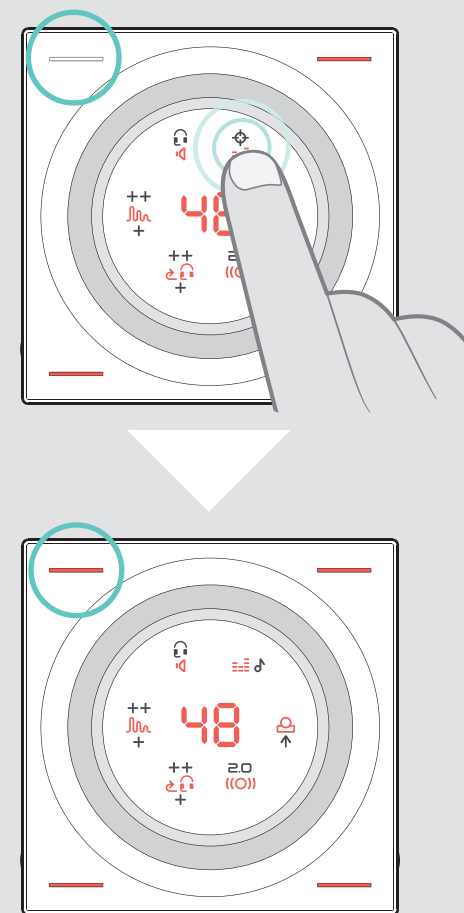

触摸并按住预设键, 以开启/关闭巡回赛模式*

*如有需要, 请升级固件。

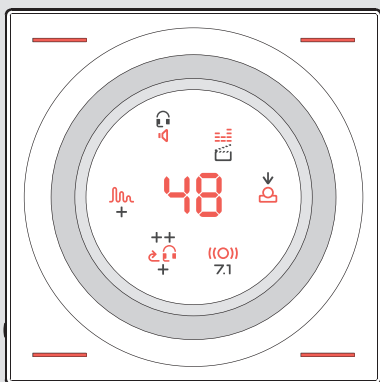

更改设置

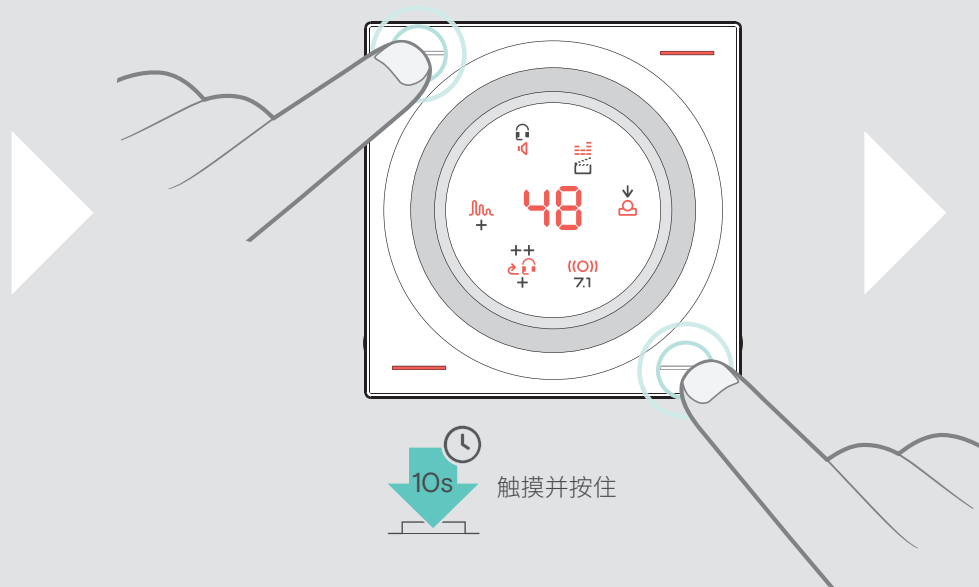

触摸并按住

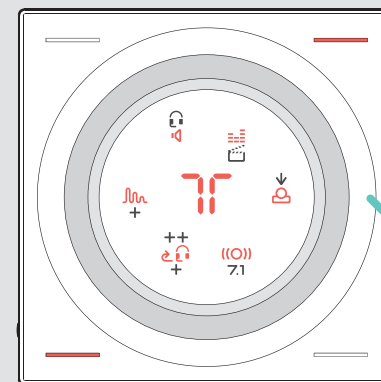

设置已锁定



Tournament Mode

巡回赛模式功能

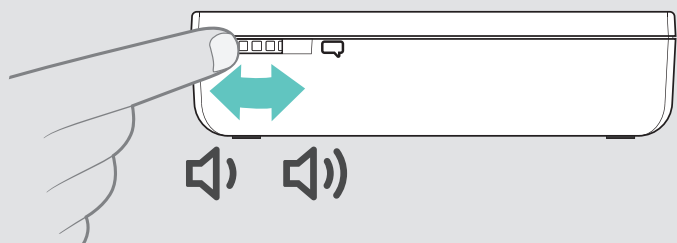

更改传入的聊天音量

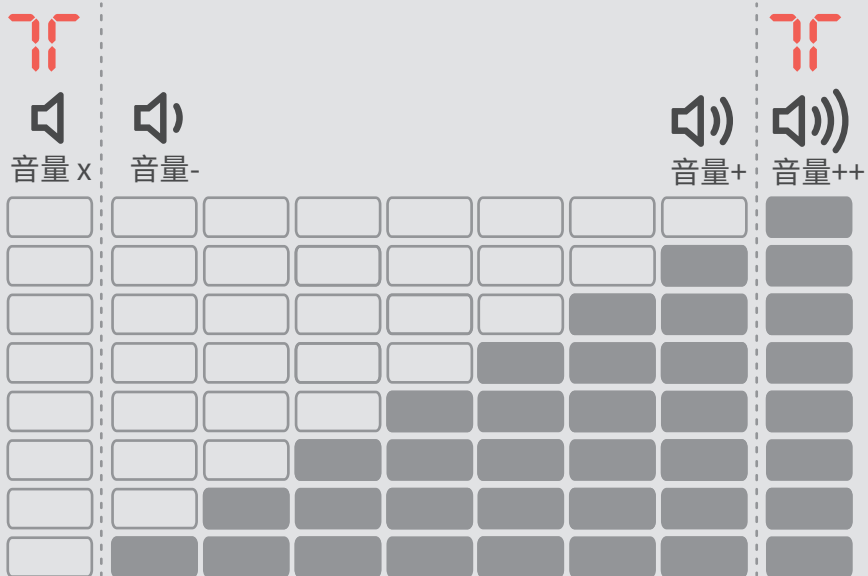

通过音量旋钮更改音量

音量- 音量+

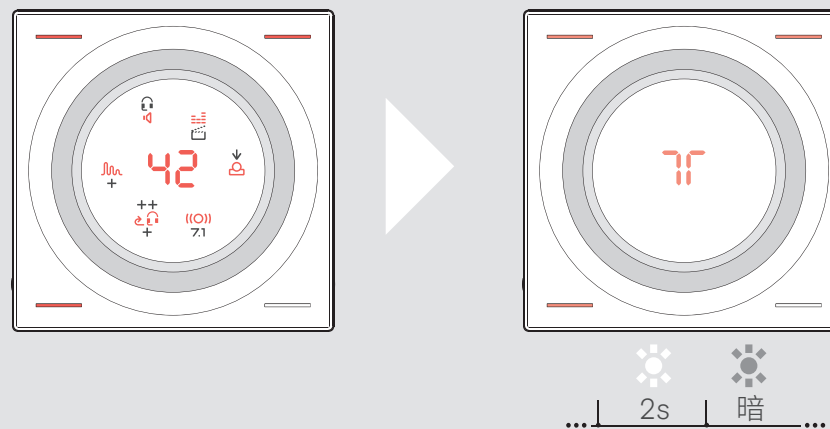
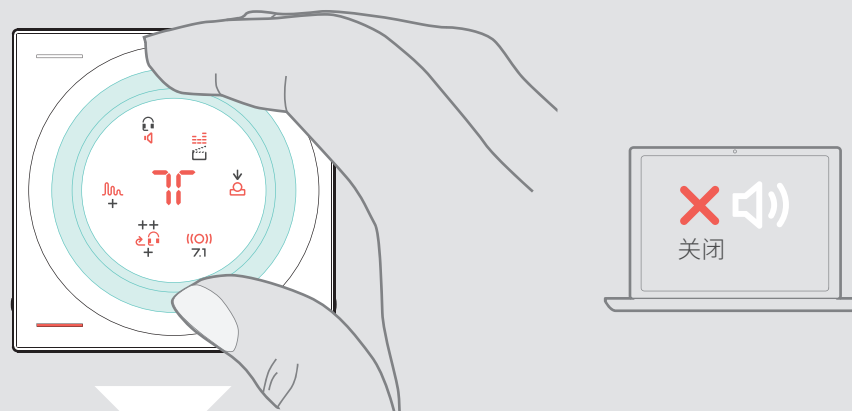



巡回赛模式功能

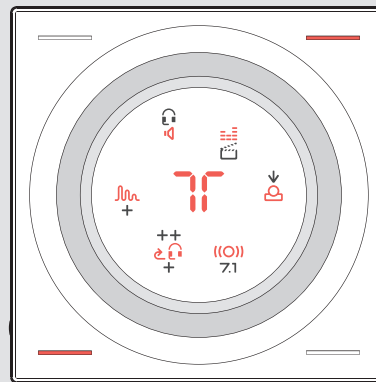
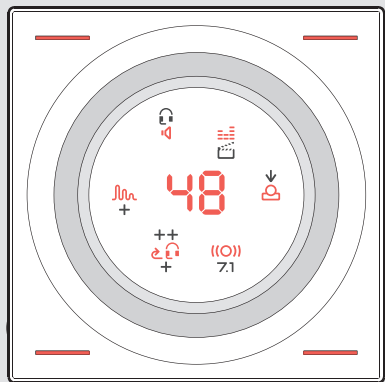

Yes! Wow!
What?
Help!

Yes! Wow!
What?
Help!

已启用麦克风路径
上的积极降噪功能

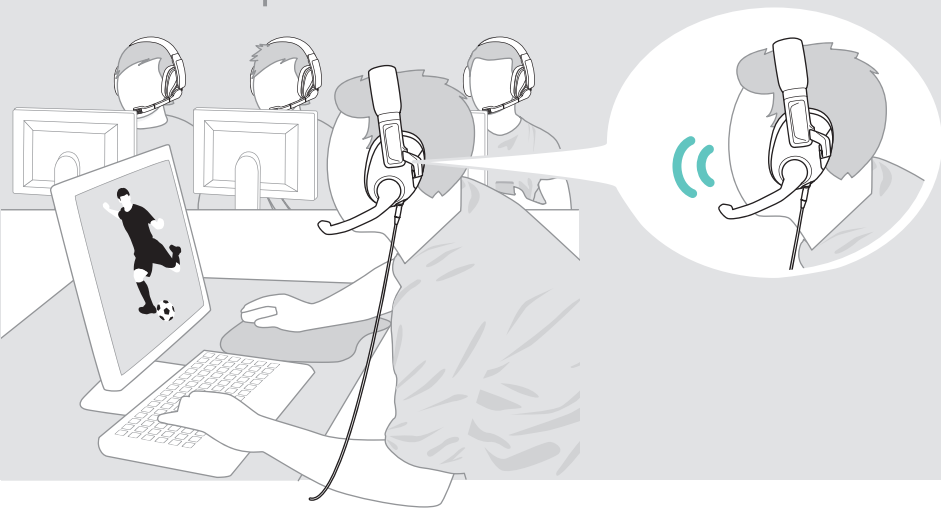

请大声讲话

用柔软、干燥的擦拭布清洁本产品

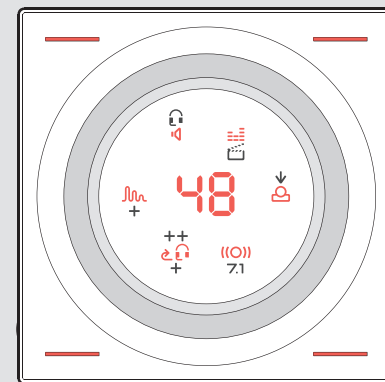
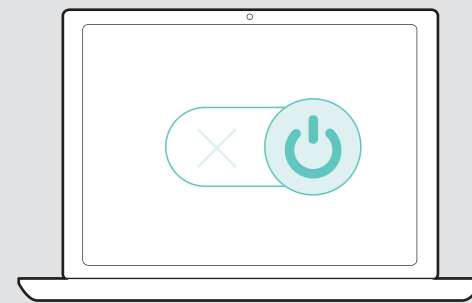
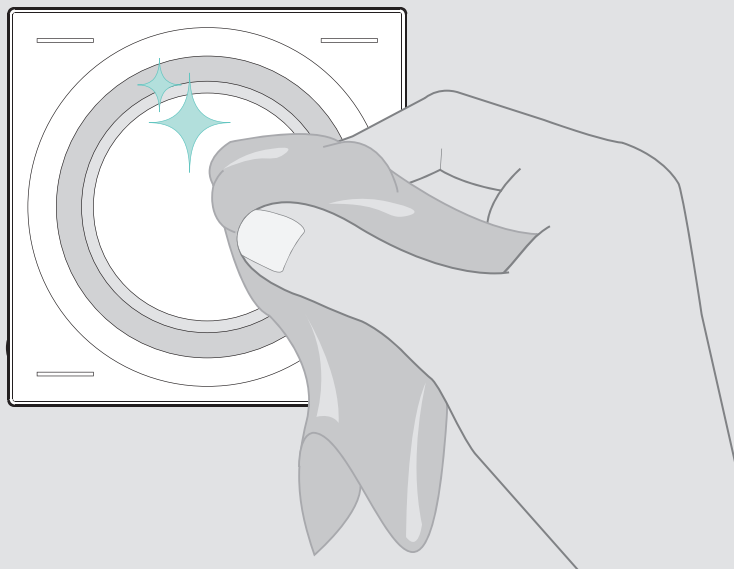
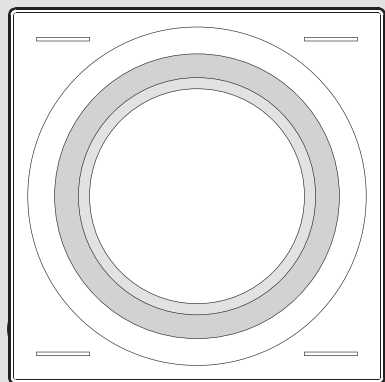
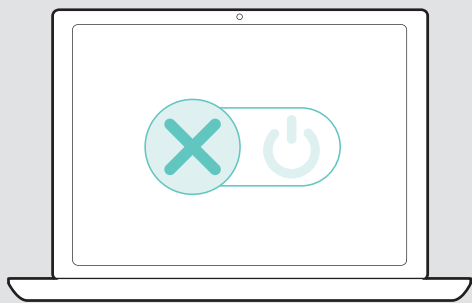

触摸所有预设键进行重置

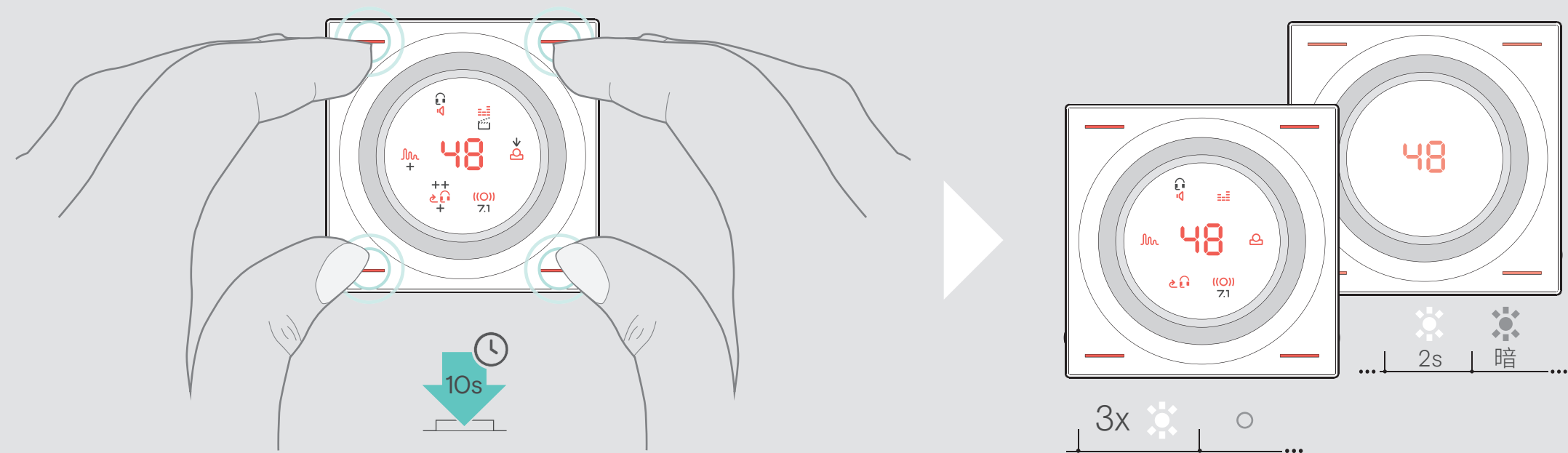

EPOS

请访问我们的网站，
了解更多信息和教程：

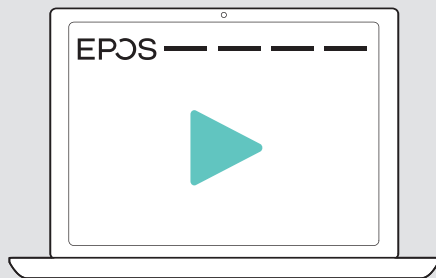

www.eposaudio.com/gaming



请联系我们的
产品服务支持：

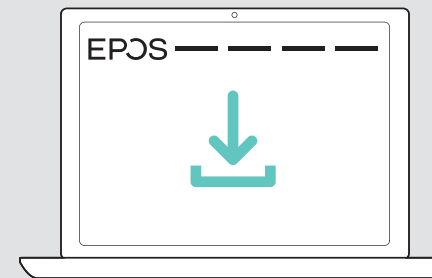

www.eposaudio.com/gaming/support

DSEA A/S

Kongebakken 9, DK-2765 Smørum, Denmark

www.eposaudio.com