

EPOS

CEHS-SP 01

Splitter cable for electronic hook switch

- EN Quick Guide
- DE Kurzanleitung
- FR Guide express
- IT Guida rapida
- ES Guía rápida
- PT Guia Rápido
- NL Mini handleiding
- EL Γρήγορος οδηγός
- DA Kvikvejledning
- SV Snabbguide
- FI Pikaopas
- PL Skrócona instrukcja obsługi
- RU Краткое руководство
- TR Hızlı Kılavuz
- JA クイックガイド

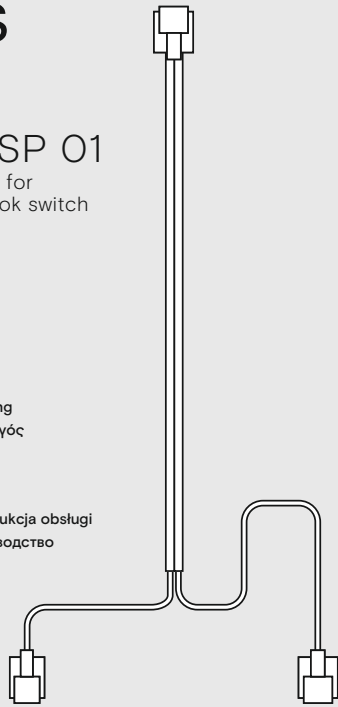

www.eposaudio.com/support



www.eposaudio.com/connect

In compliance with:

Europe



DSEA A/S

Kongebakken 9, DK-2765 Smørum, Denmark
www.eposaudio.com

Printed in China, Publ. 08/20, 770-00173/A03

Package contents | Lieferumfang | Contenu de la boîte | Contenuti della confezione | Contenido del embalaje | Conteúdo da embalagem | Inhoud verpakking | Περιεχόμενα συσκευασίας | Pakkens inhoud | Innehåll i förpackningen | Pakkauksen sisältö | Zawartość opakowania | Содержимое упаковки | Kutunun içeriği | パッケージ内容

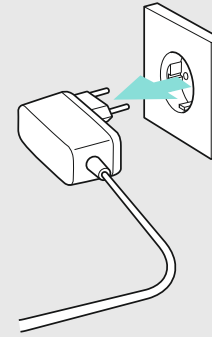
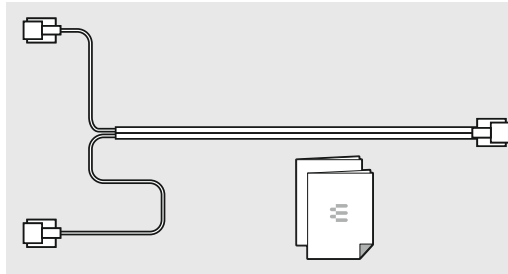

- ▶ Before connecting the adapter cable, disconnect the base station from the mains.
- ▶ Trennen Sie die Basisstation vom Netz, bevor Sie das Adapterkabel anschließen.
- ▶ Avant de connecter le câble adaptateur, déconnecter la base de l'alimentation secteur.
- ▶ Prima di connettere il cavo adattatore, disconnettere la postazione di base dall'alimentazione.
- ▶ Antes de conectar el cable adaptador, desconecte la estación base de la red eléctrica.
- ▶ Antes de ligar o cabo adaptador, desligue a estação de base da electricidade.
- ▶ Haal de stekker van het basisstation uit het stopcontact vóór het aansluiten van de adapterkabel.
- ▶ Πριν συνδέσετε το καλώδιο προσαρμογέα, αποσυνδέστε τον σταθμό βάσης από το δίκτυο.
- ▶ Før adapterkablet tilsluttes, skal basestationens strømstik tages ud af stikkontakten.
- ▶ Fráknoppla basstationen frá elnæti innan du ansluter adapterkabeln.
- ▶ Irrota tukiaseman virtajohto pistorasiasta ennen sovitinjohdon liittämistä.
- ▶ Przed połączeniem kabla przejściowego, odłączyc stację bazową od źródła zasilania.
- ▶ Перед подключение переходного кабеля отключите базовую станцию от сети электропитания.
- ▶ Fráknoppla basstationen frá elnæti innan du ansluter adapterkabeln.
- ▶ アダプターケーブルの接続前にベースステーションの主電源を切ってください。

1 Base station | Basisstation | Base | Postazione di base | Estación base | Estação de base | Basisstation | Σταθμός βάσης | Basestation | Basstation | Tukiasema | Stacja bazowa | Базовая станция | Basstation | ベースステーション |

IMPACT DW series

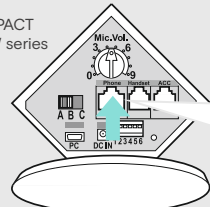

Phone



IMPACT SD series

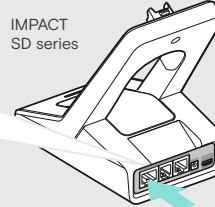

IMPACT D 10 series

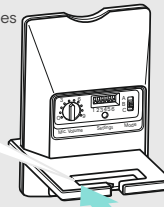

IMPACT SDW 5000 series

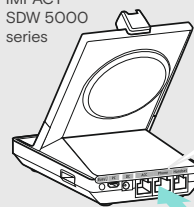

2 DW/SD/D10 series

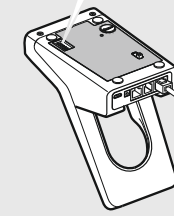
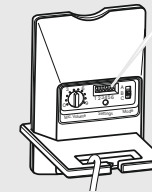
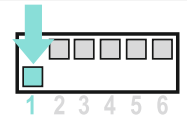
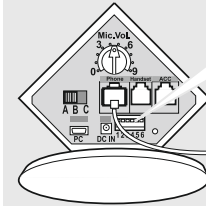

SDW 5000 series



Advanced configuration: EPOS Connect www.eposaudio.com/connect

3

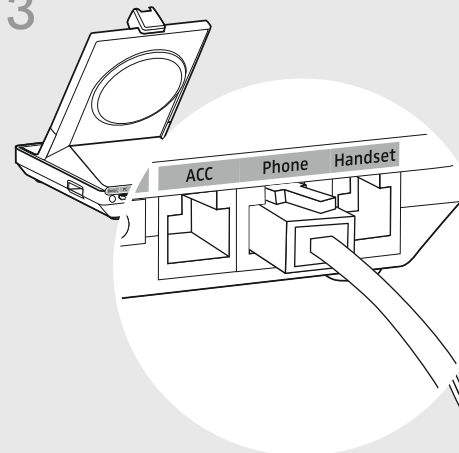

Base of the telephone | Unterseite Telefon | Base du téléphone | Base del telefono | Base del teléfono | Base do telefone | Basis van de telefoon | Βάση του τηλεφώνου | Telefonens underside | Telefonens bas | Puhelimen pohja | Podstawa telefonu | База телефона | Telefonens bas | 電話のベース

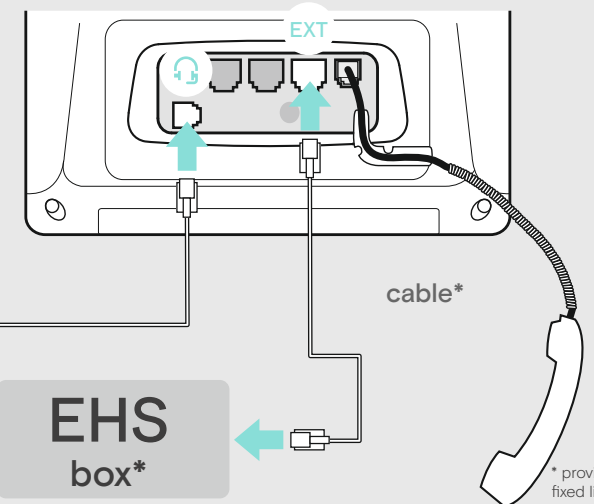

EHS box*

* provided by the fixed lined phone