

EPOS



B20

Streaming Microphone

Model: EPWD2

User Guide

Contents

Welcome	2
Package contents	3
B20 microphone at a glance	4
Mounting the B20	5
Mounting the B20 on the desk stand	5
Mounting the B20 on a microphone arm	6
Connecting your devices	7
Connecting to a computer	7
Connecting to a PlayStation	8
Connecting a headphone / headset	9
Securing the cables	10
Setting up your computer	11
Changing the audio settings	11
Installing the EPOS Gaming Suite	11
Using the B20	12
Getting to know the pick-up patterns	12
Selecting a pick-up pattern	13
Rotating and talking into the B20	14
Adjusting the recording volume	15
Adjusting the listening volume	16
Muting the microphone	16
EPOS Gaming Suite: Additional settings	17
Adjusting the noise cancellation	17
Adjusting the sidetone	18
Adjusting your voice	18
If a problem occurs	19
How to care for your B20	20
Cleaning the product	20
Updating the firmware	21
Specifications	22

Welcome

The EPOS B20 streaming microphone with integrated audio controls gives you full control over your sound with volume, gain, mute and a choice of four pickup patterns – cardioid, stereo, bidirectional and omnidirectional – to cover every recording scenario, from solo game streams to team-play broadcasts.

Intuitive LEDs show when the microphone is active or muted and a headphone jack lets you monitor your voice in real time in balance with game audio, and make adjustments on the fly.

Take your streaming game to the next level with our broadcast quality, hassle-free, digital plug-and-play microphone.

A microphone with flexible setup options that will grow and step up with you as you expand and advance on your gaming content creation.

Key benefits & features

Studio quality streaming microphone

Captures and transmits your voice and game audio effortlessly

Hassle free USB connection

Plug-and-play for hassle-free ease of use Integrated audio controls Intuitive audio controls right at your fingertips

Choice of four pickup patterns

Choose from four microphone pickup patterns to suit any recording scenario





Monitor in real time

Built-in headphone jack for monitoring of your voice and game audio

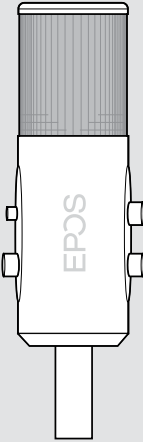
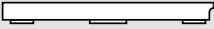

For safety instructions, consult the Safety Guide.

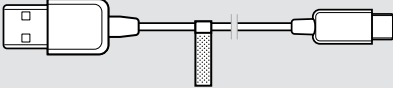
Package contents

	<p>B20 Streaming Microphone</p>
	<p>Desk stand</p>
	<p>Screw for desk stand</p>
	<p>USB-A to USB-C® cable with velcro strip for cable alignment</p>
	<p>Quick Guide Safety Guide Compliance sheet</p>

B20 microphone at a glance

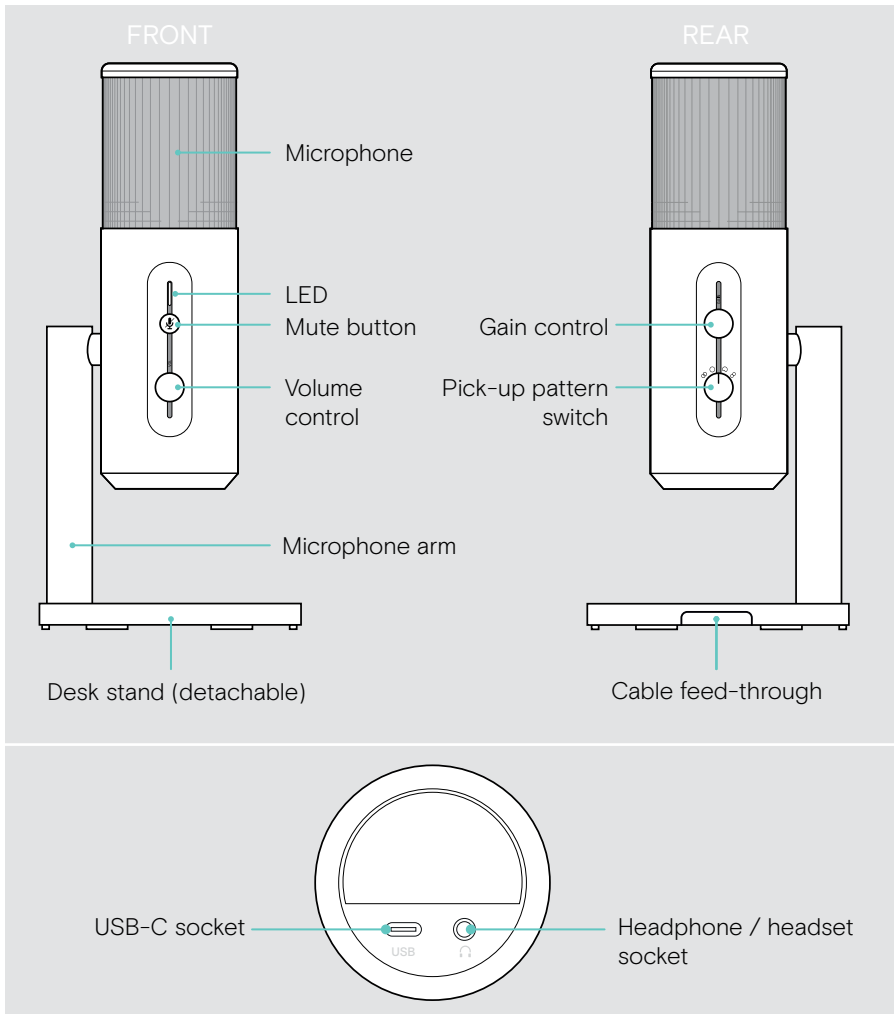

Mounting the B20

You can use the B20 with the delivered desk stand or mount it to a microphone arm.

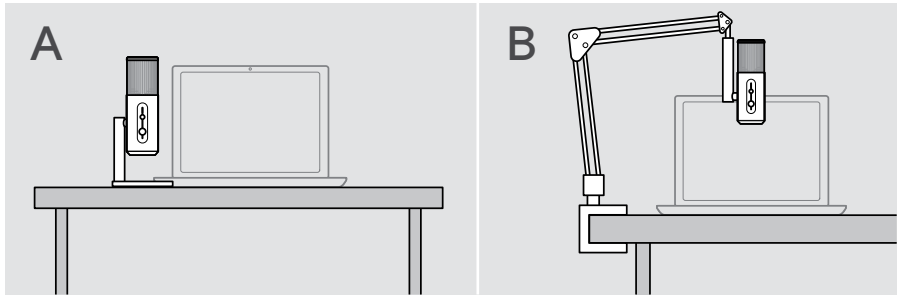

Mounting the B20 on the desk stand

- > Align the microphone arm and screw hole of the desk stand.
- > Hold them together and insert the screw to affix it.
- > Place the B20 on your desk.

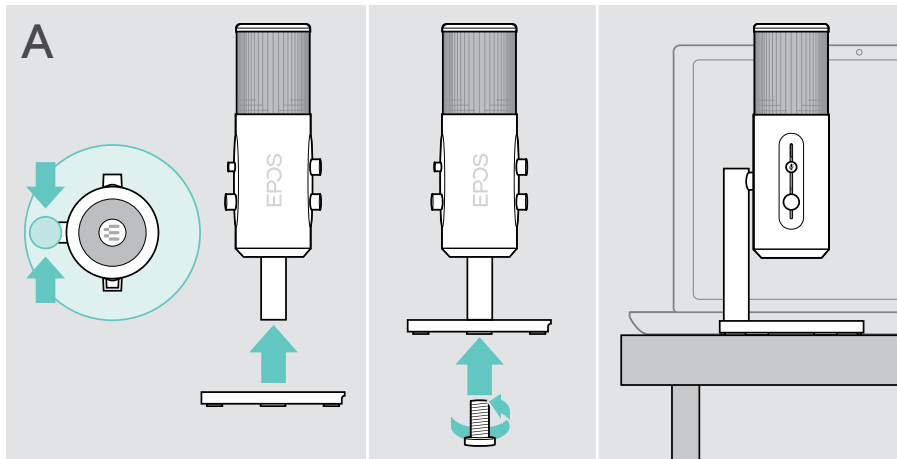

Mounting the B20 on a microphone arm

You can attach the B20 to any microphone arm with a standard 3/8" thread.

- > Bring the microphone arm in place and rotate it until you reach the mechanical stop of your microphone arm.
- > Rotate the B20 so that the LED and Mute button points towards you.

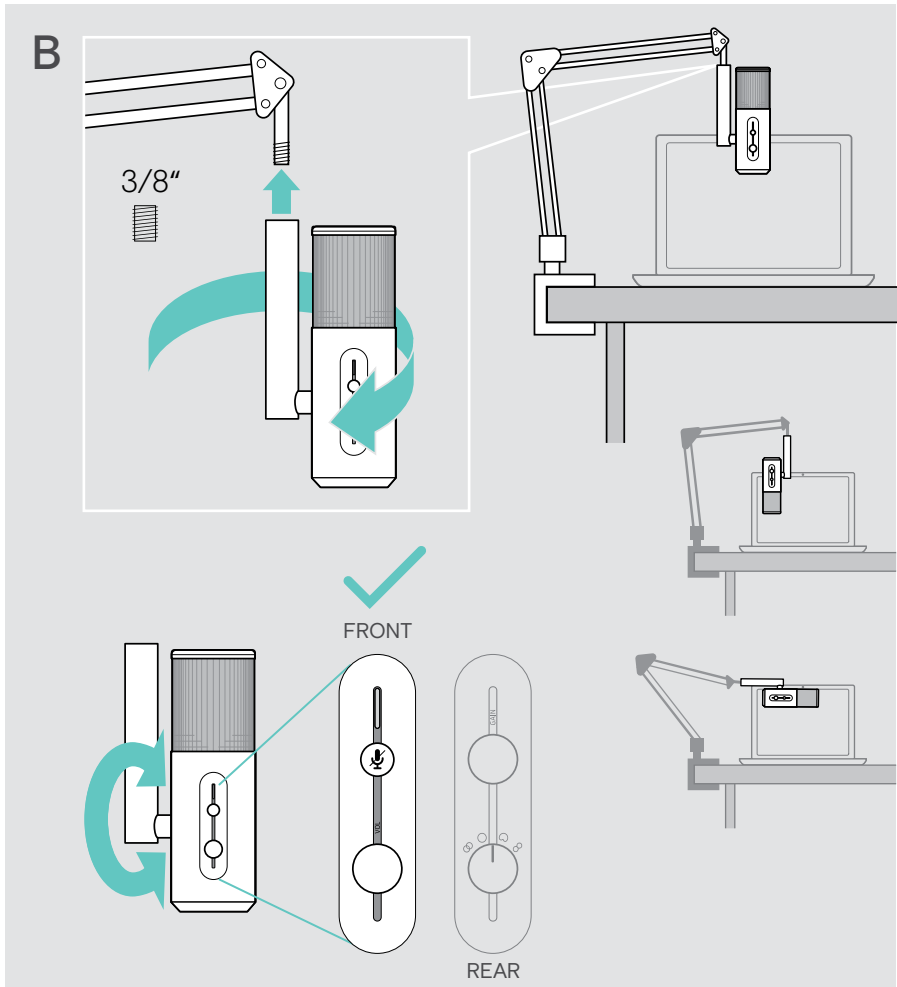

Connecting your devices

You can connect your B20 microphone either to your computer or your PlayStation PS5™ or PS4™. With an additional headphone or headset you can monitor your recording.

Connecting to a computer

- 1 Plug the small connector into the USB port of the B20.
If you use the desk stand: Use the cable feed-through to align the cable.
- 2 Plug the large connector into a **USB-A** port of your computer.
The microphone turns on automatically. The LED lights up white.

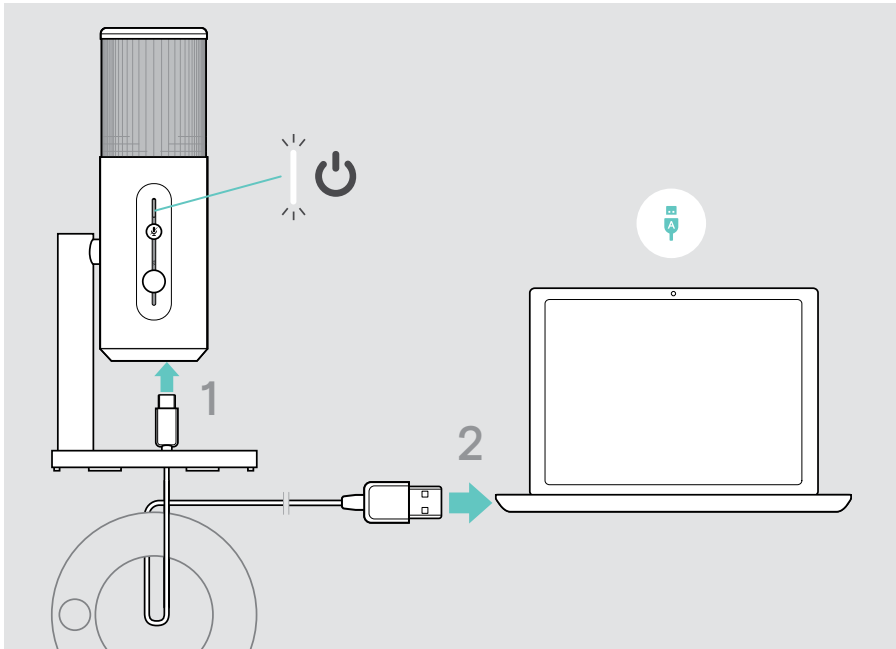

Connecting to a PlayStation

- 1 Plug the small connector into the USB port of the B20.
If you use the desk stand: Use the cable feed-through to align the cable.
- 2 Plug the large connector into a **USB-A** port of your PlayStation.
The microphone turns on automatically. The LED lights up white.

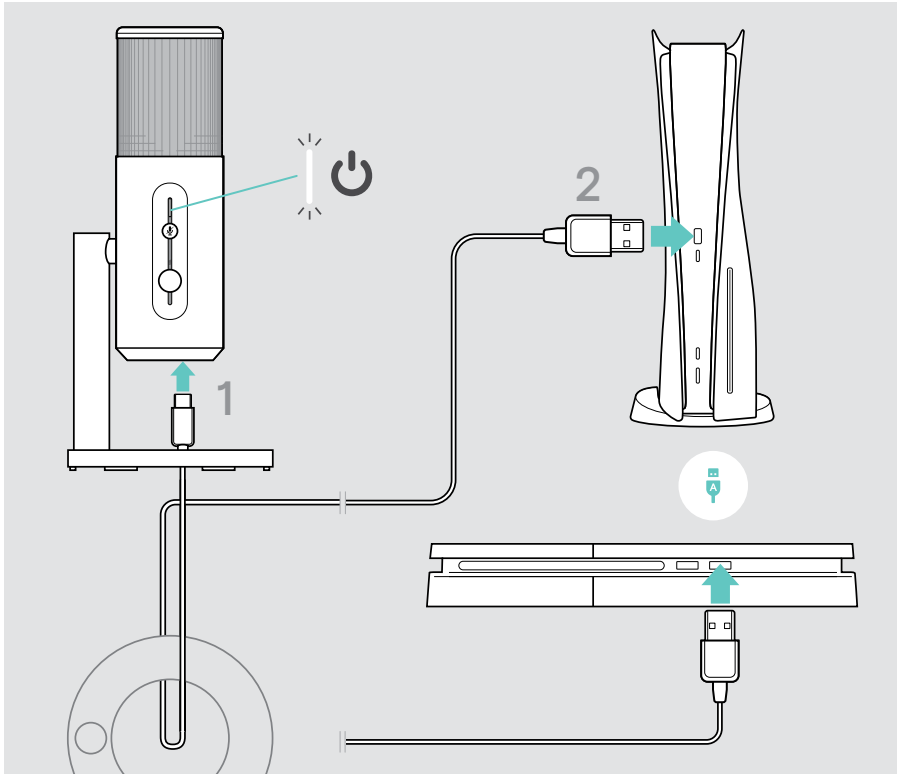

Connecting a headphone / headset



CAUTION

Risk of hearing damage!

Listening at high volume levels for long periods can lead to permanent hearing defects.

- > Set the volume to a low level before putting on the headset. Do not continuously expose yourself to high volumes.

With a connected headphone or headset you can live monitor your recording with zero-latency. Or you can listen to your recordings, any media, game sound or chat.

- > Plug the **3.5 mm** (1/8") jack plug of your headphone or headset into the B20.

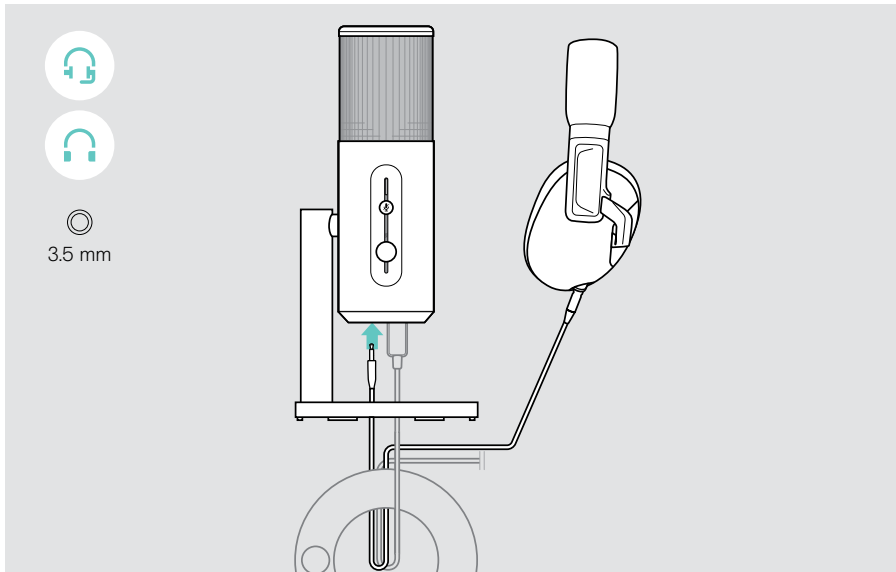

If you use a headset with the B20, make sure that B20 is selected as default playback device in Windows – see page 11.

Securing the cables

- > Use the velcro strip of the USB cable to tie and secure the cables e.g. at your microphone arm.

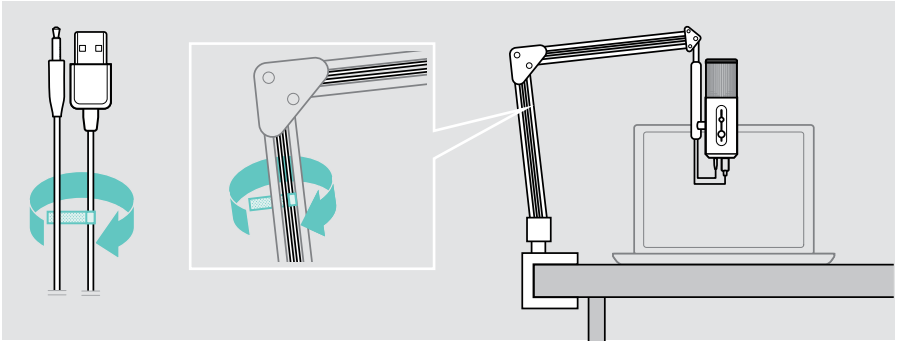

Setting up your computer

Changing the audio settings

Your computer usually changes the Audio settings automatically if you connect new devices.

If the recording does not work or if you hear no sound:

- > Open the Audio settings.
- > Select under input **EPOS B20** as **microphone** (studio quality).
- > Select under output **EPOS B20** as **speaker**.



Installing the EPOS Gaming Suite

The free software **EPOS Gaming Suite** allows you to add value to your B20.

- 1 Download the software from www.eposaudio.com/gaming/downloads.
- 2 Install the software.

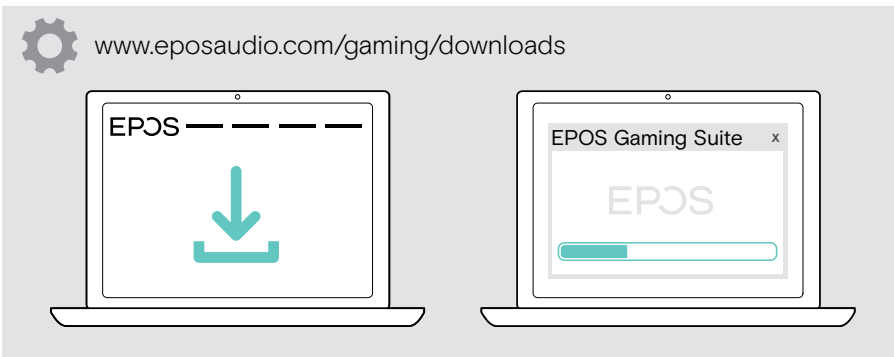

Using the B20

Getting to know the pick-up patterns

With the pick-up patterns the B20 can focus more on your voice instead of ambient noise. It also offers different settings for joining friends or guest speakers.

You can choose between four different pick-up patterns: Cardioid, Bidirectional, Stereo or Omnidirectional.

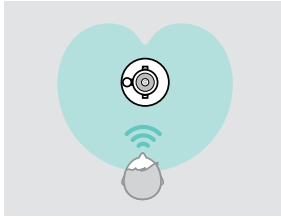

Cardioid is the best choice if you do recordings **alone**: In this setting sound recording focuses on the front. Sounds from the sides are quieter and from the rear nearly not captured.

- > Rotate the B20 so that the LED light is pointing towards you.

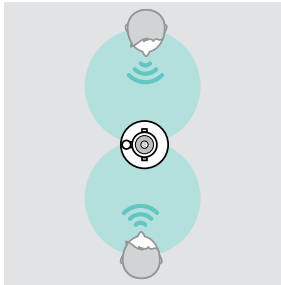

Bidirectional is optimized for speech recordings with **one guest**. Sounds in the front and rear of the B20 are recorded whereas sounds from the sides are not picked up or very reduced.

- > Rotate the B20 so that the LED light is pointing towards you. Place your guest on the opposite side of the B20 with a similar distance.

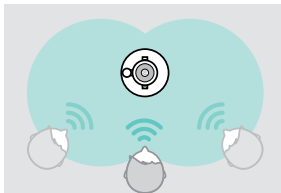

Stereo works very similar to the human hearing and sounds very natural. It focuses on the left and right side and mixes sounds in front. If you move while talking it will be picked up with the impression of **movement**.

- > Make sure the B20 LED light is pointing towards the primary user/users.

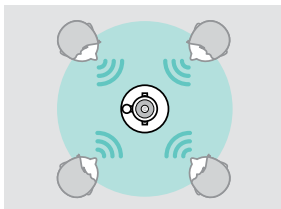

Omnidirectional is perfect if you have **several guests** to join your recording. In this mode sounds are captured from all sides with the same volume – without any focus.

- > Place the B20 in the center of your participants.

Selecting a pick-up pattern

- > Rotate the pick-up pattern switch to select the appropriate pattern. The pattern is shown in the EPOS Gaming Suite.

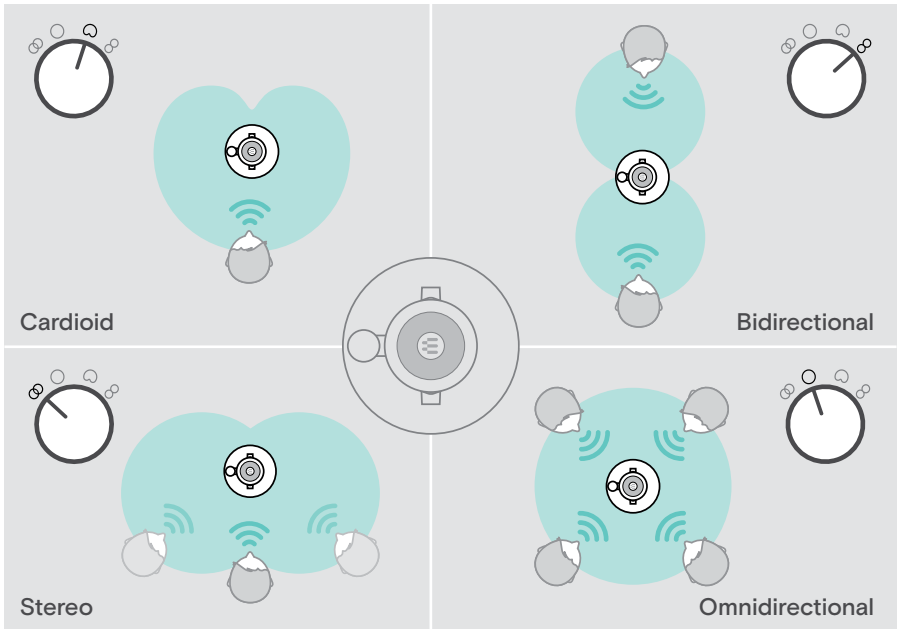
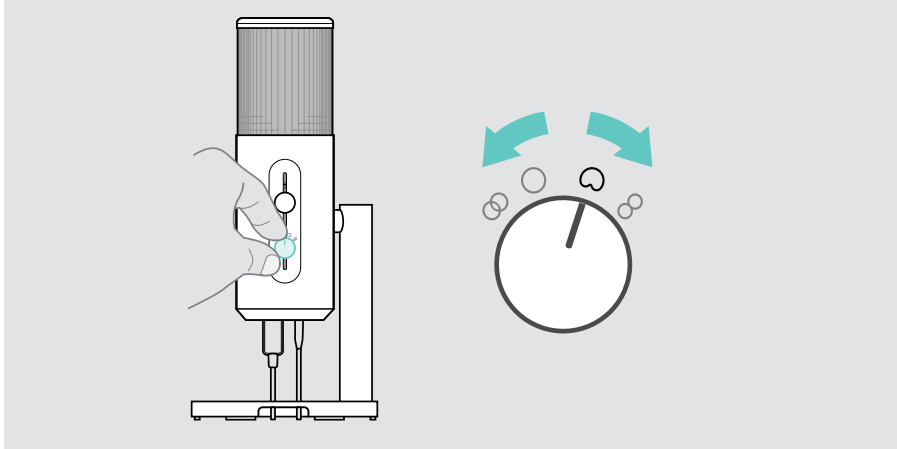

Rotating and talking into the B20

- > Rotate the microphone – if required.

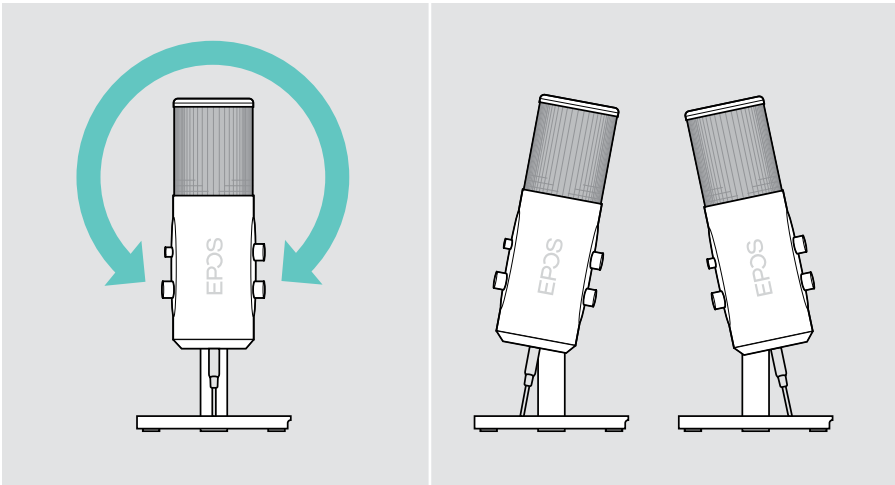

- > Talk into the B20 from the side and not from the top or bottom.

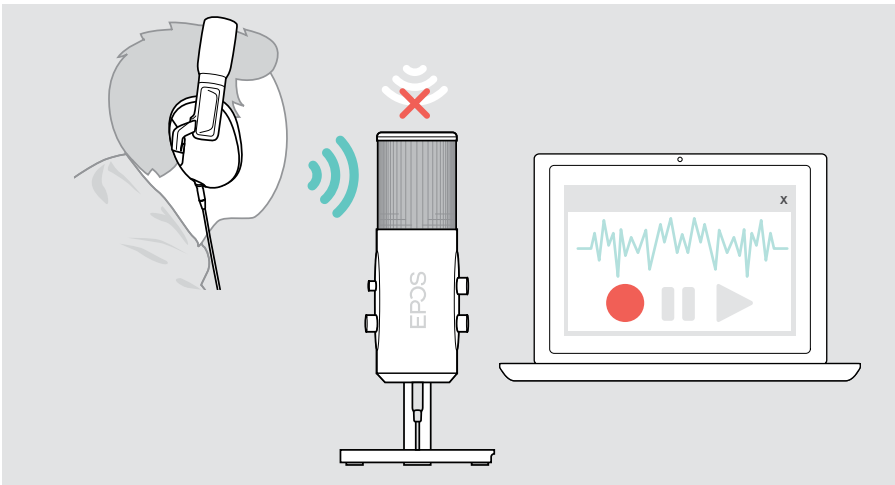

The direction of speech depends on the [pick-up pattern](#) setting – see former chapter.

The [distance](#) between you and the B20 influences the recording volume – see next chapter.

Adjusting the recording volume

You can change the recording volume by:

- **A** increasing or decreasing the distance between you and your B20,
- **B** talking louder or quieter and
- **C** adjusting the microphone gain as a fine-tuning.

If you sit far away from the microphone a higher gain is required. If the gain is very high you hear ambient noises louder and might have an echo effect.

If you are too close you hear pop noises e.g. if you pronounce a hard letter like a P.

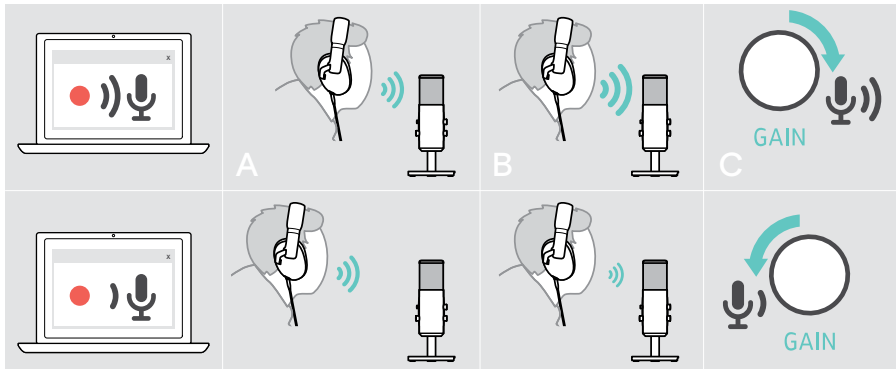

- > Optimize the distance between you and the B20.
- > Rotate the Gain control to increase or decrease the volume of your picked-up voice. The level is shown in the EPOS Gaming Suite.

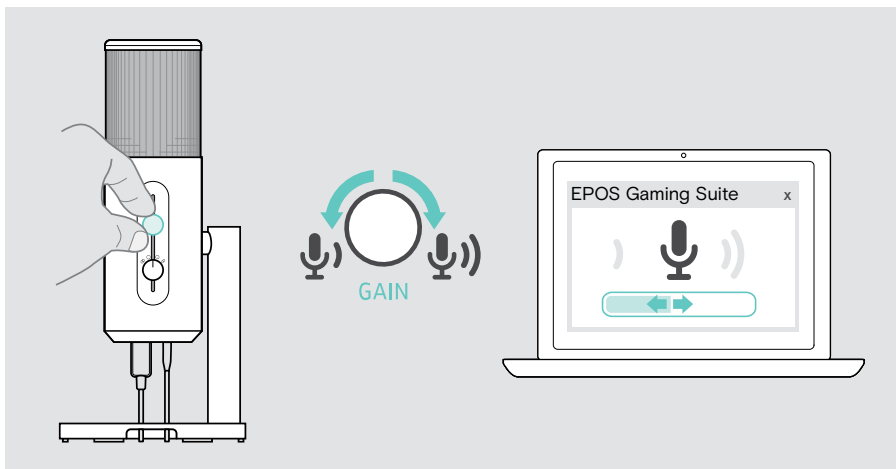

Adjusting the listening volume

You can adjust the volume via your connected device or the B20.

- > Rotate the Volume control to increase or decrease the speaker volume of the connected headset or headphone. Volume level for monitoring is shown in the EPOS Gaming Suite and on your computer screen.

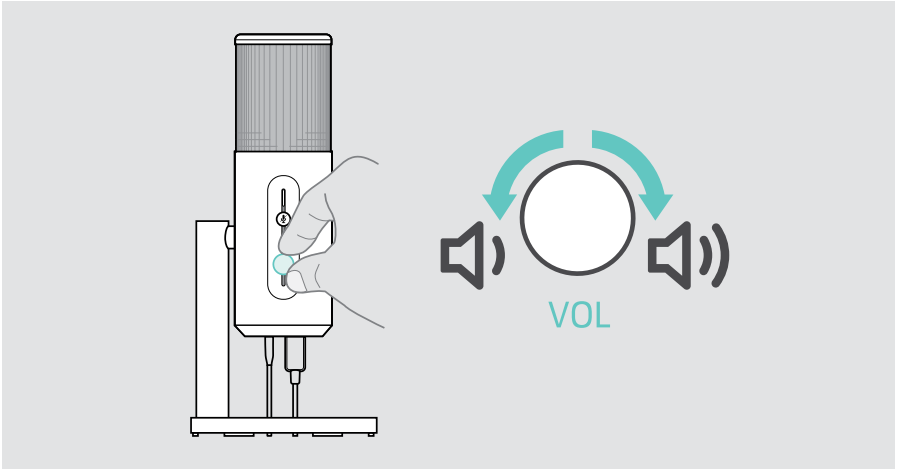

Muting the microphone

- > Press the Mute button on the B20 or in the EPOS Gaming Suite to stop or start the recording of your voice. The microphone is muted or unmuted. The LED lights up red while muted. Mute is shown in the EPOS Gaming Suite.

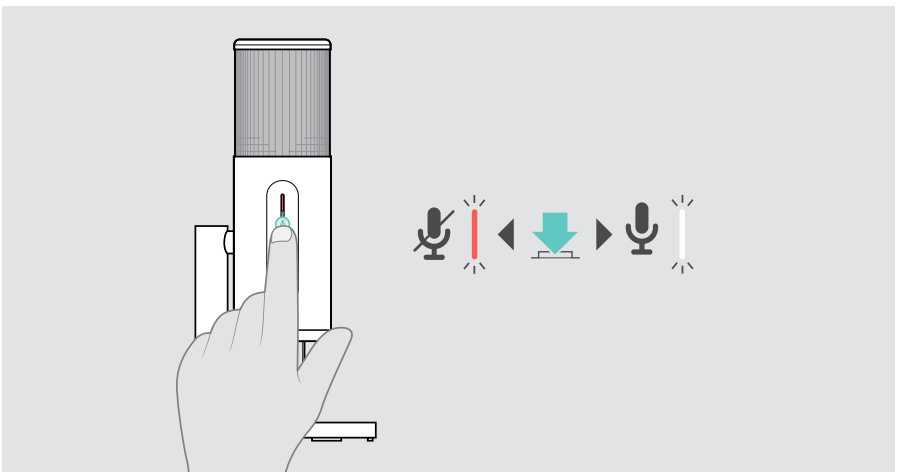

EPOS Gaming Suite: Additional settings

The EPOS Gaming Suite includes a bunch of features that can improve the audio experience of your B2O even more.

The following chapters explain some example features. Play around and try to create settings that fit your needs.

Adjusting the noise cancellation

Increasing noise cancellation will reduce background noise, but may also deteriorate the recording quality. We recommend setting noise cancellation to 0 if there is no background noise.

- > Go to the microphone tab of the EPOS Gaming Suite to check and change the Noise cancellation features.

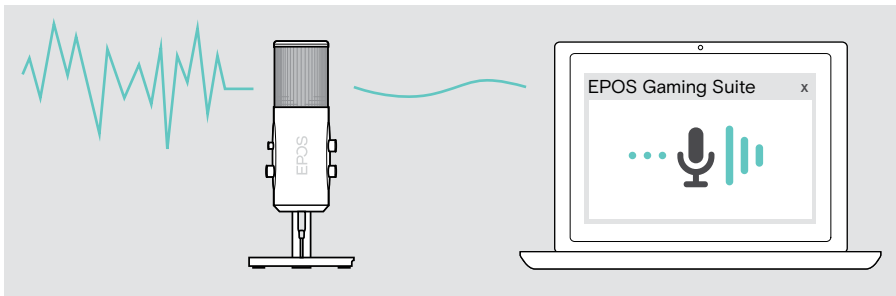

Adjusting the sidetone

Sidetone (monitor) allows you to hear what the microphone picks up. A sidetone setting will remain in the device until you change it again.

- > Go to the microphone tab of the EPOS Gaming Suite and adjust the Sidetone.

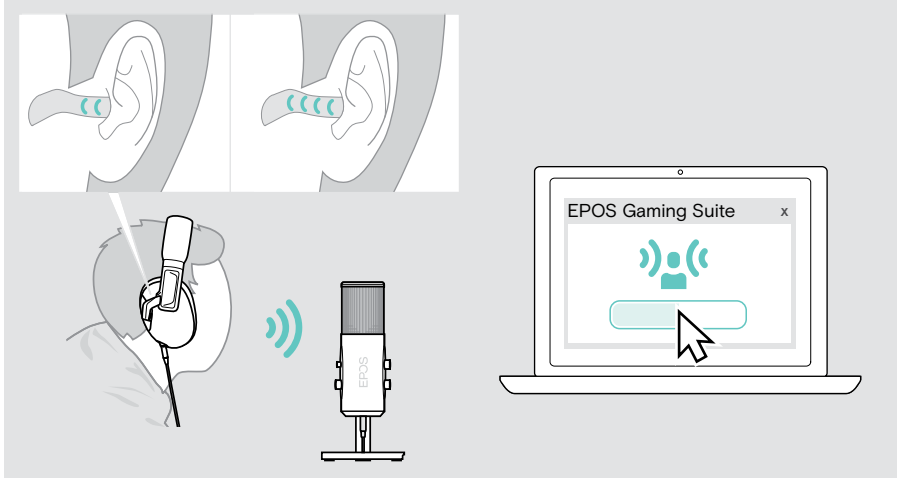

Adjusting your voice

- > Go to the microphone tab of the EPOS Gaming Suite.
- > Check the examples and test the different effects of the Microphone equalizer.

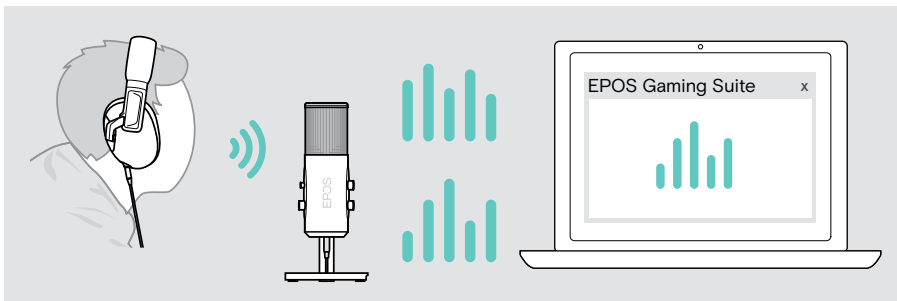

If a problem occurs ...

Problem	Possible cause	Solution	Page
B2O does not turn on	USB plugs not fully inserted	> Insert the plugs again.	7
No recording	B2O muted	> Unmute the microphone.	16
	B2O not set as default device	> Go to Windows audio settings and set as default playback/ recording device.	11
Bad audio quality	Talking into the top or bottom of the B2O	> Talk into the B2O from the side.	14
	Wrong direction of speech for selected pick-up pattern	> Change your position or select a different pick-up pattern.	13
	Wrong mounting	> Make sure that the mute button points towards you.	6
	You are too close or far away from the B2O	> Increase or decrease the distance to the B2O	–
	You talk too loud or quiet for the current setting	> Talk louder or quieter or change settings.	11
	Microphone Gain too high or low	> Adjust the microphone gain.	11
You hear pop sounds	You are too close to the B2O	> Increase the distance to the B2O.	–
Loud ambient noises or echo effect	Microphone Gain too high	> Reduce the gain level and come a bit closer to the B2O.	11
	Wrong direction of speech for selected pick-up pattern	> Change your position or select a different pick-up pattern.	13
No audio in the headset	Plug not fully inserted	> Insert the plug again.	9
	Speaker volume for the headset adjusted too low on the B2O	> Increase the volume.	16
	Volume adjusted too low on the connected device		–
B2O does not react to any button press	Software or hardware problems	> Unplug and plug in the B2O again.	7

If a problem occurs that is not listed here or if the problem cannot be solved with the proposed solutions, contact your local EPOS partner for assistance.

To find a EPOS partner in your country, search at www.eposaudio.com.

How to care for your B20

Cleaning the product

CAUTION

Liquids can damage the electronics of the product!

Liquids entering the housing of the device can cause a short circuit and damage the electronics.

- > Keep all liquids far away from the product. Do not use any cleansing agents or solvents.
 - > Use a dry cloth to clean the product.
-

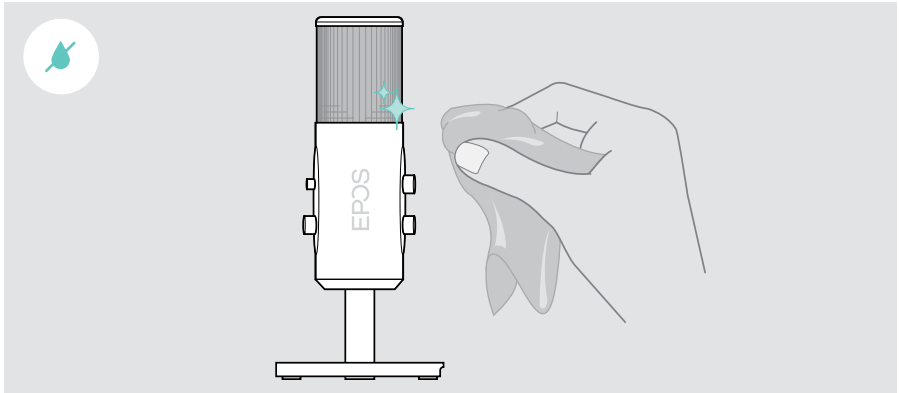

Updating the firmware

- 1 Connect the USB cable to the B20 and your computer. The LED lights up.
- 2 Start the [EPOS Gaming Suite](#).
If there is a new firmware available the software will guide you through the update process.

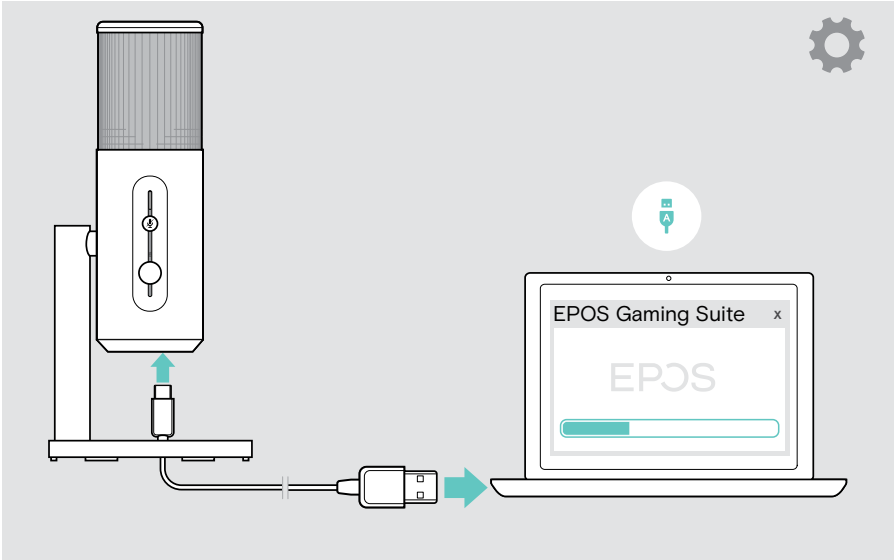

Specifications

Dimensions (H x W x D)	239 x 122 x 122 mm 9.41 x 4.80 x 4.80 in
Weight (with cable)	530 g / 1.17 lbs / 18.70 oz
Connectors	<ul style="list-style-type: none">• USB-C• 3.5 mm jack for headset/headphone
Compatibility	PC, Mac, PS5™, PS4™
Microphone pick-up patterns	Cardioid, Bidirectional, Stereo, Omnidirectional
Frequency response	50 – 20,000 Hz

Trademarks

USB Type-C® and USB-C® are trademarks of USB Implementers Forum.

“PlayStation” is a registered trademark or trademark of Sony Interactive Entertainment Inc. also “PS5” and “PS4” are trademarks of the same company.

All other trademarks are the property of their respective owners.

EPOS

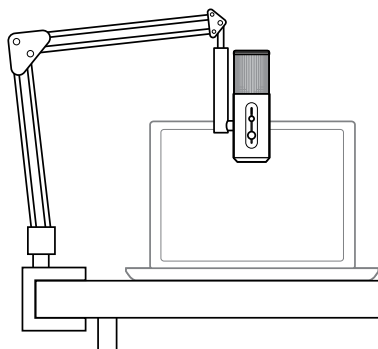
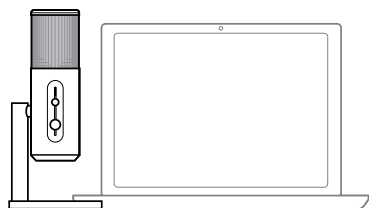
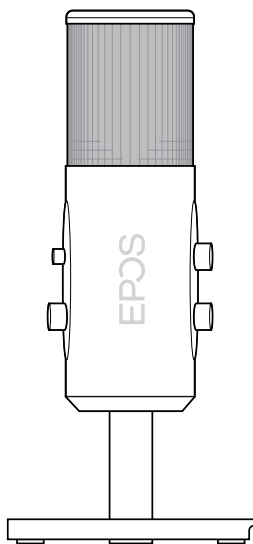

DSEA A/S

Kongebakken 9, DK-2765 Smørum, Denmark

www.eposaudio.com

Publ. 01/22, A02